



棘轮扳手与套筒

选择实耐宝工具，意味着拥有**最佳的方法**

专业人士在工作中需要合适的工具，实耐宝是最好的选择。无论是表面镀铬或是经工业处理，无论是小到可置于掌心或是大到与人一样高，实耐宝80余种棘轮扳手中必有一款可以满足用户需求。

选择实耐宝工具，意味着拥有**创新的设计**

自从实耐宝革命性推出可换头Flank Drive® 套筒系统的设计后，9种方头尺寸、配合1500余种不同的套筒，多达200可选式样，使得实耐宝产品可以面对用户所有需求。创新，让实耐宝可以最快了解并满足专业用户的需求。

英制/公制6角套件

144TMPB-6角英制/公制套件

共44件工具, 包括:

6角浅套筒		6角深套筒		6角公制浅套筒		6角公制深套筒	
TM6	3/16"	STM6	3/16"	TMM5.5	5.5mm	STMM5.5	5.5mm
TM7	7/32"	STM7	7/32"	TMM6	6mm	STMM6	6mm
TM8	1/4"	STM8	1/4"	TMM7	7mm	STMM7	7mm
TM9	9/32"	STM9	9/32"	TMM8	8mm	STMM8	8mm
TM10	5/16"	STM10	5/16"	TMM9	9mm	STMM9	9mm
TM11	11/32"	STM11	11/32"	TMM10	10mm	STMM10	10mm
TM12	3/8"	STM12	3/8"	TMM11	11mm	STMM11	11mm
TM14	7/16"	STM14	7/16"	TMM12	12mm	STMM12	12mm
TM16	1/2"	STM16	1/2"	TMM13	13mm	STMM13	13mm
TM18	9/16"	STM18	9/16"	TMM14	14mm	STMM14	14mm



144TMPB



还包括:

- T936 高强度密封棘轮扳手
- TMU8B 万向接头
- TMXK2 2" 凸边延长杆
- TMXK60 6" 凸边延长杆
- PB99A 塑料盒

公制6角套件

117TMM

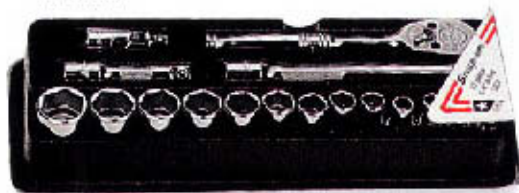

117TMM-6角公制简易套件

共17件工具, 包括:

6角公制浅套筒:

TMM4	4mm	TMM9	9mm
TMM5	5mm	TMM10	10mm
TMM5.5	5.5mm	TMM11	11mm
TMM6	6mm	TMM12	12mm
TMM7	7mm	TMM13	13mm
TMM8	8mm	TMM14	14mm
		TMM15	15mm

还包括:

- T936 高强度密封棘轮扳手
- TMU8B 万向接头
- TMXK2 2" 凸边延长杆
- TMXK4 4" 凸边延长杆

英制6角套件

134ATMP-6角常用工具套件

共34件工具, 包括:

6角浅套筒		6角深套筒		还包括:	
TM6	3/16"	STM6	3/16"	TM4CSA	长柄母头驱动把
TM7	7/32"	STM7	7/32"	TM10G	6" 变向手柄
TM8	1/4"	STM8	1/4"	TM61A	6" 可弯曲延长杆
TM9	9/32"	STM9	9/32"	TM67A	棘轮转接头
TM10	5/16"	STM10	5/16"	TM82	一字套筒螺丝刀头, .036 x 1/4"
TM11	11/32"	STM11	11/32"	TM408	8角套筒, 1/4"
TM12	3/8"	STM12	3/8"	TM410	8角套筒, 5/16"
TM14	7/16"	STM14	7/16"	TM412	8角套筒, 3/8"
TM16	1/2"	STM16	1/2"	T936	高强度密封棘轮扳手
TM18	9/16"	STM18	9/16"		

134ATMP



- TMS70A 棘轮旋转头
- TMU8B 万向接头
- TMXK2 2" 凸边延长杆
- TMXK4 4" 凸边延长杆
- TMXK60 6" 凸边延长杆

可选附件:

- KRA275A 金属盒
- KRA284B 金属盒

12DTMPB



120DTMPB-6角常用工具套件

共20件工具, 包括:

6角浅套筒

TM6	3/16"
TM7	7/32"
TM8	1/4"
TM9	9/32"
TM10	5/16"
TM11	11/32"
TM12	3/8"
TM14	7/16"
TM16	1/2"
TM18	9/16"

还包括:

- TM4CSA 长柄母头驱动把
- TM10G 6" 变向手柄
- TM408 8角套筒, 1/4"
- TM410 8角套筒, 5/16"
- TM412 8角套筒, 3/8"
- T936 高强度密封棘轮扳手
- TMU8B 万向接头
- TMXK2 2" 凸边延长杆
- TMXK4 4" 凸边延长杆
- TMXK60 6" 凸边延长杆

可选附件:

- KRA255A 金属盒

1/4" 方头 常用工具套件

114TMPB



114TMPB-6角常用工具套件(金属盒)
114ATMP-6角常用工具套件(塑料盒)

共14件工具, 包括:

6角浅套筒

TM6	3/16"	TM11	11/32"
TM7	7/32"	TM12	3/8"
TM8	1/4"	TM14	7/16"
TM9	9/32"	TM16	1/2"
TM10	5/16"	TM18	9/16"

还包括:

T936	高强度密封棘轮扳手
TMU8B	万向接头
TMXK2	2" 凸边延长杆
TMXK4	4" 凸边延长杆
KRA229	金属盒

113ATMPB 6角常用工具套件(金属盒)

113BTMP 6角常用工具套件(塑料盒)

共13件工具, 包括:

6角浅套筒

TM6	3/16"	TM11	11/32"	TF936	高强度密封棘轮扳手
TM7	7/32"	TM12	3/8"	TMXK2	2" 凸边延长杆
TM8	1/4"	TM14	7/16"	TMXK4	4" 凸边延长杆
TM9	9/32"	TM16	1/2"	KRA229	金属盒
TM10	5/16"	TM18	9/16"		

还包括:



113ATMPB



英制6角/12角套件



167ATMB

167ATMB-6/12角常用工具套件

共67件工具, 包括:

6角浅套筒

TM04	1/8"	TM10	5/16"	STM6	3/16"	STM11	11/32"
TM05	5/32"	TM11	11/32"	STM7	7/32"	STM12	3/8"
TM6	3/16"	TM12	3/8"	STM8	1/4"	STM14	7/16"
TM7	7/32"	TM14	7/16"	STM9	9/32"	STM16	1/2"
TM8	1/4"	TM18	9/16"	STM10	5/16"	STM18	9/16"
TM9	9/32"						

6角深套筒

还包括

TM4CSA	1/4" 长柄母头驱动把	TM84	一字套筒螺丝刀头, 1/32" x 7/16"	TMA7E	内6角套筒螺丝刀头, 7/32"	TMU81A	12角万向套筒, 1/4"
TM5	滑动T型扳手, 4 1/2"	TM408	8角套筒, 1/4"	TMA8E	内6角套筒螺丝刀头, 1/4"	TMU101A	12角万向套筒, 5/16"
TM10G	变向手把, 6"	TM410	8角套筒, 5/16"	TMC104E	一字套筒螺丝刀头, 3/16" x .032"	TMU121A	12角万向套筒, 3/8"
TM27	离合式套筒方头, 3/16"	TM412	8角套筒, 3/8"	TMC105E	一字套筒螺丝刀头, 1/4" x .032"	TMU141A	12角万向套筒, 7/16"
TM30	离合式套筒方头, 1/4"	T936	高强度密封棘轮扳手	TMC106E	一字套筒螺丝刀头, 3/8" x .032"	TMU161A	12角万向套筒, 1/2"
TM31	离合式套筒方头, 5/32"	TMA2.5E	内6角套筒螺丝刀头, 5/64"	TMP12E	#1十字套筒螺丝刀头	TMU181A	12角万向套筒, 9/16"
TM61A	可弯曲延长杆, 6"	TMA3E	内6角套筒螺丝刀头, 3/32"	TMP22E	#2十字套筒螺丝刀头	TMXK2	2" 凸边延长杆
TM62B	可弯曲驱动把, 6 3/4"	TMA3.5E	内6角套筒螺丝刀头, 7/32"	TMP23E	长十字套筒螺丝刀头	TMXK4	4" 凸边延长杆4"
TM65	可弯曲调节杆	TMA4E	内6角套筒螺丝刀头, 1/8"	TMS4E	快卸摇把, 16"	TMXK60	6" 凸边延长杆6"
TM67A	棘轮转接头	TMA4.5E	内6角套筒螺丝刀头, 9/64"	TMS70A	棘轮旋转头	TMXK140	14" 凸边延长杆14"
TM82	一字套筒螺丝刀头, 1/4" x .036"	TMA5E	内6角套筒螺丝刀头, 5/32"	TMU8B	万向接头	KRA282B	金属盒
TM83A	一字套筒螺丝刀头, 1/32" x 23/64"	TMA6E	内6角套筒螺丝刀头, 3/16"				

工具套件(附加件)

107ATMPB可扩充常用工具套件及附加件

用107ATMPB这一常用工具套件, 附加以下建议的套筒套件, 可以根据需要组成1/4" 方头工具套件。塑料盒内空间可容纳2排标准长度、半深、深或万向套筒套件, 或是任意的公英制套筒组合

共7件工具, 包括:

TM4CSA	长柄母头驱动把, 1/4"	TMXK4	4" 凸边延长杆
TM10G	变向手把, 6"	TMXK60	6" 凸边延长杆
T936	高强度密封棘轮扳手	TMU8B	万向接头, 1/4" 方头
TMXK2	2" 凸边延长杆	PB24	塑料盒

建议附加件

110TMY	6角浅套筒套件(10件)
110STMY	6角浅套筒套件(10件)
111TMMDY	12角公制浅套筒套件(11件)
111STMMDY	12角公制浅套筒套件(11件)
106ETMAMY	公制内6角套筒方头套件(6件)



107ATMPB

棘轮扳手

Snap-on® 高强度密封棘轮扳手

专利设计，内部扩孔，采用高科技技术密封。特殊的O型环不仅可永久密封并润滑油，还可阻挡灰尘、污垢、湿气和其他污染物。便于使用，无需日常维护。美国专利号：4,934,220 和 6,125,722。

圆头棘轮扳手

外型细长，可在狭窄区域内正常工作。39齿棘轮。

多向头棘轮扳手

多功能。棘轮头定位方向达17个。按动头部下方的栓定机构，便可使头部在“锁定位”或“未锁定位”。开关按钮用一只手指就可操控。即使在狭窄的工作区域，只要头部在“未锁定位”，仅需简单推/拉的动作即可使工具更称手。360° 曲柄运动可增强棘轮效应。棘轮最小工作角度为6°，对工作空间的要求较小。头部密封于石墨油中，可阻挡灰尘、污垢、湿气和其他污染物。美国专利号：5,419,221和5,495,783。

HY-LOK® 紧固式棘轮扳手

在扳手头部与方头中有个特制的洞。可用内六角板固定，就像拧紧紧固件的颈部。



高强度密封棘轮扳手						H	W	L		
T936	GT936	标准手柄	密封	标准	36	10°	7/16	7/8	4 7/16	RKRT936
TL936	-	长手柄	密封	标准	36	10°	7/16	7/8	6 1/2	RKRT936
T936FOD*	-	标准手柄(FOD型)	密封	标准	36	10°		7/8	4 7/16	
TF936	-	长手柄可翻转头	密封	标准	36	10°	7/16	7/8	4 1/2	RKRT936
THL936A	-	长手柄	密封	标准	36	10°	7/16	7/8	6 7/8	RKRT936
TX936	-	可锁定翻转头	密封	软柄(红)	36	10°	7/16	7/8	6 5/32	RKRT936
THLF936A	-	长手柄可翻转头	密封	标准	36	10°	7/16	7/8	8 1/4	RKRT936
TSLF936	-	快卸手柄	密封	软柄(红)	36	10°	7/16	7/8	11	RKRT936
TR936	-	标准手柄，快卸头	密封	标准	36	10°	7/16	7/8	4 7/16	RKRT936
圆头棘轮扳手										
TK860	-	短手柄	圆头	标准	60	6°	9/16	15/16	3 1/16	RKRT860
T860	-	标准手柄	圆头	标准	60	6°	9/16	15/16	4 1/2	RKRT860
TH737	-	长手柄可翻转头	圆头	软柄(红)	60	9°	9/16	1 7/32	6 7/8	RKRT739
TMR739	-	手指操控	圆头	标准	60	9°	9/16	1 1/2	4 1/2	RKRT739
HY-LOK® 紧固式棘轮扳手										
-	TFY936	标准手柄	HY-LOK®	标准	20	18°	3/8	1 5/16	4 7/16*	RKRATM75AHL

ASME/ANSI B107.10M-1996

*: 此类棘轮扳手专为在敏感环境中工作，防止外物损伤而设计。盖板与棘轮头部用铆钉连接，不易产生小碎片。

1/4" 方头 棘轮扳手套件及附件

棘轮扳手套件

104RAT – 圆头棘轮扳手套件

1/4" 方头TK860, T860和TH737 1/4" 方头圆头棘轮扳手, 及TMS70A棘轮旋转头(4件), 配塑料盒



104RAT

RATM803A



RATM803A – 1/4" 密封头部棘轮扳手套件

T936, TL936和TF936 1/4" 方头密封头部棘轮扳手(3件), 配塑料盒

RAT936



RAT936 – 组合方头密封头部棘轮扳手套件

1/4" 方头T936, 3/8" F936和1/2" S936(3件), 配塑料盒

附件



棘轮转接头

	A	B
TM67A	20	18"
GTM67A	15/16	1 3/8

棘轮旋转头

	A	B
TMS70A	31/32	27/32

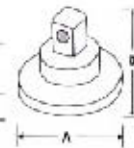

130UFTS



万向接头

	A	B
TMU8B	1/2	1 5/16
GTMU8B		

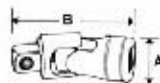

103UFTS – 组合方头万向接头套件:

1/4" 方头TMU8B, 3/8" 方头FU8A, 和1/2" 方头S8(3件), 配塑料盒

1206GS



方头转接头

	A	B	C	D
GFAT1E	3/8	1/4	21/32	1 1/8
TA3	1/4	3/8	1/2	15/16

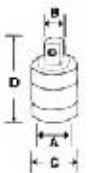

1206GS – 组合方头转接头套件:

1/4" 方头TM1和TA3转接头, 3/8" 方头A2A和A1MF转接头, 及1/2" 方头GLA12B和GLA62转接头(6件), 配滑轨及套筒夹

206XMSP



磁性转接头

	A	B	C
TMXM17	7/32	13/32	1 21/32
TMXM14	7/32	9/32	1 17/32

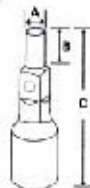

206XMSP – 组合方头磁性转接头套件:

1/4" 方头TMXM17和TMXM114转接头, 3/8" 方头FXM18和FXM112转接头, 及1/2" 方头SXM212和SXM222转接头(6件), 配滑轨及套筒夹

警告:

- 请勿将镀铬或经工业处理的手动工具应用于动力工具
- 时常检查, 清理并用轻质油润滑棘轮机械装置部分
- 使用工具箱内的全套部件, 不要个别替换零件

附件 1/4" 方头



短粗手柄驱动把



	E	C
TM40ASA	1 3/4	2 1/8

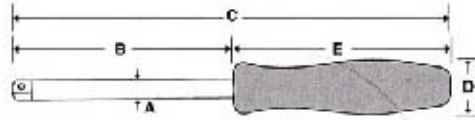

棘轮驱动把



	A	B	C
TMR4	3 7/8	5 3/32	8 31/32



可锁驱动把



	A	B	C
GM4B	5/16	2	5 21/32



长手柄驱动把



	A	B	C
TM4B	5/16	2 1/16	5 3/4



T形手柄棘轮驱动把



	D	E	C
TMRT8	26	13.8°	3



把手端有方头

长手柄母头驱动把

手柄内置方头，可配合不同手柄使用



	A	B	C
SGT4	5/16	2 3/8	6
TM9CSA	5/16	6 3/8	10



可弯曲驱动把



	A	B	C
TM62B	1/4	2 7/32	6 3/4
TM63A	1/4	4 21/32	9 3/16

特大可弯曲驱动把



	A	B	C
TM615	1/4	6 21/32	18 5/8



1/4" 方头 附件

可弯曲延长杆

	A	B	C
TM61A	5/16	5	6

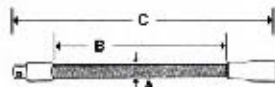

凸边可锁延长杆

快速卸除有助于方便快捷的从延长杆上卸下套筒。方头端部有凸边，可以简单的用指尖转动。

	A	B
TMXKL60	5/16	6
TMXKL110	5/16	11
TMXKL240	3/8	24

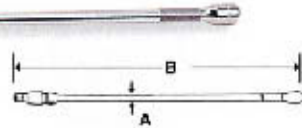

103TMXKL-凸边可锁延长杆套件:
TMXKL6至TMXKL240(3件), 配塑料盒

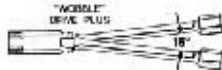

凸边活动延长杆

	A	B
TMXWP1	5/16	1 1/4
TMXWP2	5/16	2
TMXWP4	5/16	4
TMXWP6	5/16	6
TMXWP8	5/16	8
TMXWP11	5/16	11

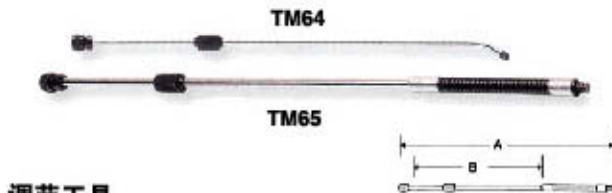
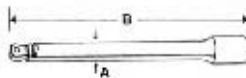

调节工具

	A	B	轴型
TM64	18 1/4	16	刚性
TM65	19 3/4	14 1/4	可弯曲



软手柄变向手把

	A	B	C	D
THBB10	19/32	13/16	3 1/4	6 15/32

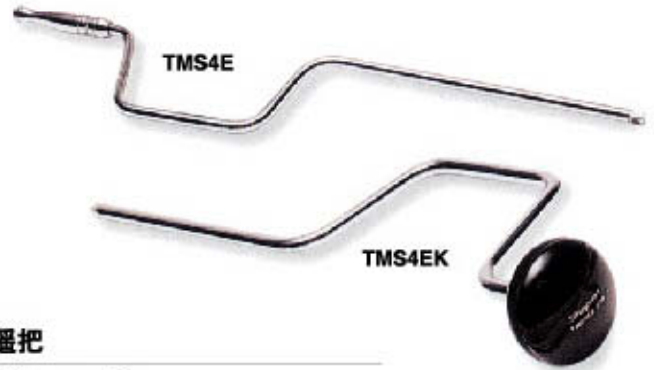
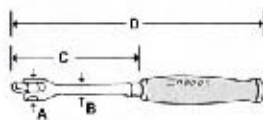

快卸遥把

	A	B	C	D
TMS4E	5/16	7 1/8	3	16



106BTMX



凸边延长杆

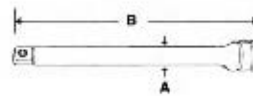

		A	B
TMX1*	-	5/16	1 1/4
TMXK2	-	5/16	2
TMXK4	-	5/16	4
TMXK60	GTMX60*	5/16	6
TMXK80	GTMXK80	5/16	8
TMXK110	GTMXK110	5/16	11
TMXK140	GTMX140*	5/16	14
TMX240*	-	3/8	24

*: 不带凸边 • ASME/ANSI B107.1M-1996
106BTMX-凸边延长杆套件:
TMXK1TMXK110(6)件, 配塑料盒



变向手把

	A	B	C
TM10G	5/16	19/32	6



T形滑动扳手

	B	A	C
TM5	5/16	13/16	4 1/2



警告:

• 请勿将镀铬或经工业处理的手动工具应用于动力工具



FLANK DRIVE® 套筒 1/4" 方头

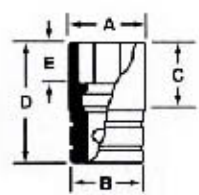

浅套筒

六角	6	12	六角	12	A	B	C	D	E
1/8	TM04	-	-	-	7/32	7/16	1/2	7/8	1/8
5/32	TM05	-	-	-	9/32	15/32	1/2	7/8	5/32
3/16	TM6*	TMD6*	GTM6	GTMD6	9/32	15/32	1/2	7/8	5/32
7/32	TM7*	TMD7*	GTM7	GTMD7	11/32	15/32	1/2	7/8	3/16
1/4	TM8	TMD8	GTM8	GTMD8	3/8	15/32	1/2	7/8	7/32
9/32	TM9	TMD9	GTM9	GTMD9	13/32	15/32	1/2	7/8	1/4
5/16	TM10	TMD10	GTM10	GTMD10	15/32	15/32	1/2	7/8	9/32
11/32	TM11	TMD11	GTM11	GTMD11	1/2	15/32	5/16	7/8	9/32
3/8	TM12	TMD12	GTM12	GTMD12	17/32	1/2	1/2	7/8	9/32
7/16	TM14	TMD14	GTM14	GTMD14	19/32	9/16	1/2	7/8	3/8
1/2	TM16	TMD16	GTM16	GTMD16	11/16	21/32	1/2	7/8	3/8
9/16	TM18	TMD18	GTM18	GTMD18	25/32	23/32	1/2	29/32	3/8
5/8	TM20	-	-	-	27/32	25/32	19/32	31/32	13/32

ASME/ANSI B107.1-1993

*: 常规六角

镀铬浅套筒套件:

113TMY - 6角浅套筒套件: TM04至TM20(13件), 配A269滑轨及套筒夹

110TMY - 6角浅套筒套件: TM6至TM18(10件), 配A265滑轨及套筒夹

110TMDY - 12角浅套筒套件: TMD6至TMD18(10件), 配A265滑轨及套筒夹

工业处理浅套筒套件:

110GTMY - 6角浅套筒套件: GTM6至GTM18(10件), 配A265滑轨及套筒夹

110GTMDY - 12角浅套筒套件: GTMD6至GTMD18(10件), 配A265滑轨及套筒夹

镀铬浅/深套筒套件:

120STTM - 6角浅/深套筒套件: TM6至TM18浅套筒, 和 STM6至STM18深套筒(20件), 配塑料盒

浅套筒

mm	6	12	A	B	C	D	E
4	TMM4*	-	6.7	12.1	13.3	22.2	4.6
4.5	TMM4.5*	-	7.2	12.1	13.3	22.2	4.3
5	TMM5*	TMMD5*	7.7	12.1	13.3	22.2	4.3
5.5	TMM5.5	TMMD5.5	8.3	12.1	13.3	22.2	4.6
6	TMM6	TMMD6	9.3	12.1	13.3	22.2	5.6
7	TMM7	TMMD7	10.5	12.1	13.3	22.2	6.1
8	TMM8	TMMD8	11.5	12.1	13.3	22.2	6.9
9	TMM9	TMMD9	12.7	12.1	13.3	22.2	7.4
10	TMM10	TMMD10	13.2	13.2	13.3	22.2	7.4
11	TMM11	TMMD11	15.2	14.6	13.3	22.2	9.4
12	TMM12	TMMD12	16.5	15.6	13.3	22.2	9.4
13	TMM13	TMMD13	17.6	16.7	13.3	22.2	9.4
14	TMM14	TMMD14	18.8	17.8	14.1	22.2	9.7
15	TMM15	-	20.4	19.4	14.1	23.0	9.1
16	TMM16	-	21.0	20.2	16.1	25.0	10.2

*: 常规六角

公制镀铬浅套筒套件:

115TMMY - 公制6角浅套筒套件: TMM4至TMM16(15件), 配A270滑轨及套筒夹

113TMMY - 公制6角浅套筒套件: TMM4, TMM5至TMM16(13件), 配A269滑轨及套筒夹

111TMDY - 公制12角浅套筒套件: TMMD5至TMMD14(11件), 配A265滑轨及套筒夹



1/4" 方头 FLANK DRIVE® 套筒

半深套筒

尺寸	六角		A	B	C	D	E
	6	12					
3/16"	TMS6*	TMDS6*	5/16	15/32	29/32	1 1/4	7/32
7/32"	TMS7*	TMDS7*	11/32	15/32	29/32	1 1/4	7/32
1/4"	TMS8	TMDS8	3/8	15/32	29/32	1 1/4	1/4
9/32"	TMS9	TMDS9	13/32	15/32	23/32	1 1/4	1/4
5/16"	TMS10	TMDS10	15/32	15/32	23/32	1 1/4	9/32
11/32"	TMS11	TMDS11	1/2	15/32	23/32	1 1/4	5/16
3/8"	TMS12	TMDS12	9/16	1/2	23/32	1 1/4	5/16
7/16"	TMS14	TMDS14	5/8	19/32	23/32	1 1/4	3/8
1/2"	TMS16	TMDS16	11/16	21/32	23/32	1 1/4	3/8
9/16"	TMS18	TMDS18	3/4	23/32	23/32	1 1/4	3/8

*: 常规六角

镀铬半深套筒套件:

110TMSY - 六角半深套筒套件: TMS6至TMS18(10件), 配A265滑轨及套筒夹
110TMDSY - 12角半深套筒套件: TMDS6至TMDS18(10件), 配A265滑轨及套筒夹



半深套筒

mm	六角		A	B	C	D	E
	6	12					
5	TMMS5*	TMMDS5*	7.7	12.1	22.9	31.8	5.1
5.5	TMMS5.5*	TMMDS5.5*	8.3	12.1	22.9	31.8	5.3
6	TMMS6	TMMDS6	9.3	12.1	22.9	31.8	5.8
7	TMMS7	TMMDS7	10.5	12.1	22.9	31.8	6.1
8	TMMS8	TMMDS8	11.5	12.1	18.4	31.8	6.9
9	TMMS9	TMMDS9	12.7	12.1	18.4	31.8	7.4
10	TMMS10	TMMDS10	14.0	13.2	18.4	31.8	7.4
11	TMMS11	TMMDS11	15.4	14.6	18.4	31.8	9.4
12	TMMS12	TMMDS12	16.5	15.6	18.4	31.8	9.4
13	TMMS13	TMMDS13	17.6	16.7	18.4	31.8	9.4
14	TMMS14	TMMDS14	18.8	17.8	18.4	31.8	9.7
15	TMMS15	TMMDS15	20.4	19.4	18.4	31.8	9.7

*: 常规六角

公制镀铬半深套筒套件:

112TMSY - 公制六角半深套筒套件: TMMSS至TMMSS15(12件), 配A265滑轨及套筒夹
112TMDSY - 公制12角半深套筒套件: TMMDS5至TMMDS15(12件), 配A265滑轨及套筒夹

112TMSY



112TMDSY



110STMDY

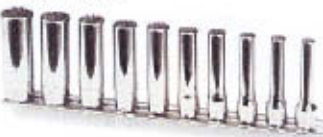

110STMY



110GSTMY



深套筒

尺寸	六角		六角		A	B	C	D	E
	6	12	6	12					
1/8	STM04*	-	-	-	7/32	7/16	1 21/32	2	1/8
5/32	STM05*	-	-	-	7/32	15/32	1 21/32	2	3/16
3/16	STM6*	STMD6*	GSTM6*	GSTM6*	7/16	15/32	1 21/32	2	3/16
7/32	STM7*	STMD7*	GSTM7*	GSTM7*	7/16	15/32	1 21/32	2	7/32
1/4	STM8	STMD8	GSTM8	GSTM8	7/16	15/32	1 21/32	2	7/32
9/32	STM9	STMD9	GSTM9**	GSTM9**	7/16	15/32	1 21/32	2	1/4
5/16	STM10	STMD10	GSTM10**	GSTM10**	7/16	15/32	1 21/32	2	7/32
11/32	STM11	STMD11	GSTM11	GSTM11	1/2	15/32	1 21/32	2	9/32
3/8	STM12	STMD12	GSTM12	GSTM12	9/16	9/16	1 21/32	2	9/32
7/16	STM14	STMD14	GSTM14	GSTM14	9/16	9/16	1 21/32	2	3/8
1/2	STM16	STMD16	GSTM16	GSTM16	11/16	21/32	1 21/32	2	3/8
9/16	STM18	STMD18	GSTM18	GSTM18	3/4	23/32	1 21/32	2	3/8

*: 常规六角

镀铬深套筒套件:

110STMY - 六角深套筒套件: STM6至STM18(10件), 配A265滑轨及套筒夹
110STMDY - 12角深套筒套件: STMD6至STMD18(10件), 配A265滑轨及套筒夹

** : 专为航空用较大的螺钉间隙直径紧固件而设计

工业处理深套筒套件:

110GSTMY - 六角深套筒套件: GSTM6至GSTM18(10件), 配A265滑轨及套筒夹
110GSTMDY - 12角深套筒套件: GSTMD6至GSTMD18(10件), 配A265滑轨及套筒夹



警告:

• 请勿将镀铬或经工业处理的手动工具应用于动力工具



FLANK DRIVE® 套筒

1/4" 方头

113STMMY



111STMMDY



124STTMM



深套筒

mm	6	12	A	B	C	D	E
4	STMM4*	-	6.7	12.1	42.2	50.8	4.6
4.5	STMM4.5*	-	7.2	12.1	42.2	50.8	4.6
5	STMM5*	STMMD5*	7.7	12.1	42.2	50.8	5.1
5.5	STMM5.5	STMMD5.5	7.7	12.1	42.2	50.8	5.1
6	STMM6	STMMD6	9.3	12.1	42.2	50.8	5.8
7	STMM7	STMMD7	10.5	12.1	42.2	50.8	6.1
8	STMM8	STMMD8	11.5	12.1	42.2	50.8	6.9
9	STMM9	STMMD9	12.7	12.1	38.1	50.8	7.4
10	STMM10	STMMD10	14.0	13.2	38.1	50.8	7.4
11	STMM11	STMMD11	15.2	14.6	38.1	50.8	9.4
12	STMM12	STMMD12	16.5	15.6	38.1	50.8	9.4
13	STMM13	STMMD13	17.6	16.7	38.1	50.8	9.4
14	STMM14	STMMD14	18.8	17.8	38.1	50.8	9.7
15	STMM15	-	20.4	19.4	38.1	50.8	9.1

*: 常规6角

公制镀铬深套筒套件:

113STMMY - 公制6角深套筒套件: STMM4、STMM5至STMM15(13件), 配A269滑轨及套筒夹

111STMMDY - 公制12角深套筒套件: STMMD5至STMMD14(11件), 配A265滑轨及套筒夹

公制镀铬浅/深套筒套件:

124STTMM - 公制6角浅/深套筒套件: TMM4至TMM14浅套筒(TMM4.5除外)

加上STMM4至STMM14深套筒(除STMM4.5)(24件), 配塑料盒

FLANK DRIVE® 万向套筒

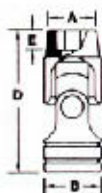

106TMUSA



万向浅套筒

mm	6	12	12	A	B	D	E
3/16"	TMUS61A*	TMU61A*	-	19/64	1/2	1 17/64	1/4
7/32"	-	TMU71A*	GTMU71A*	11/32	1/2	1 17/64	1/4
1/4"	TMUS81A	TMU81A	GTMU81A	3/8	1/2	1 17/64	1/4
9/32"	-	TMU91A	GTMU91A	27/64	1/2	1 5/16	9/32
5/16"	TMUS101A	TMU101A	GTMU101A	15/32	1/2	1 11/32	9/32
11/32"	TMUS111A	TMU111A	-	1/2	1/2	1 3/8	9/32
3/8"	TMUS121A	TMU121A	GTMU121A	17/32	1/2	1 27/64	9/32
7/16"	TMUS141A	TMU141A	GTMU141A	19/32	1/2	1 29/64	13/32
1/2"	TMUS161A	TMU161A	GTMU161A	11/16	1/2	1 33/64	13/32
9/16"	TMUS181A	TMU181A	GTMU181A	3/4	1/2	1 35/64	13/32

*: 常规6角

镀铬万向浅套筒套件:

108TMUSYA - 6角浅套筒套件: TMUS61A至TMUS181A(8件), 配A265滑轨及套筒夹

106TMUSA - 6角浅套筒套件: TMUS81A至TMUS181A(6件), 配塑料盒

106TMUA - 12角浅套筒套件: TMU81A至TMU181A(除TMU91A和TMU111A)(6件), 配塑料盒

工业处理万向浅套筒套件:

106GTMUA - 12角浅套筒套件: GTMU71A至GTMU141A(6件)



1/4" 方头

FLANK DRIVE® 万向套筒

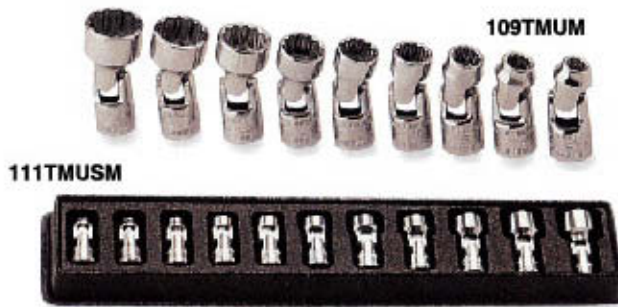

万向浅套筒

mm	6	12	A	B	D	E
5	TMUSM5A	TMUM5A	8.1	12.7	29.2	3.3
5.5	TMUSM5.5A	-	8.5	12.7	29.2	3.6
6	TMUSM6A	TMUM6A	9.6	12.7	29.7	3.8
7	TMUSM7A	TMUM7A	10.7	12.7	30.5	4.3
8	TMUSM8A	TMUM8A	11.8	12.7	30.5	4.3
9	TMUSM9A	TMUM9A	12.7	12.7	31.2	4.8
10	TMUSM10A	TMUM10A	14.0	12.7	32.5	5.8
11	TMUSM11A	TMUM11A	15.4	12.7	33.0	6.6
12	TMUSM12A	TMUM12A	16.5	12.7	34.5	6.9
13	TMUSM13A	TMUM13A	17.3	12.7	36.8	7.6
14	TMUSM14A	-	18.8	12.7	38.6	8.6
15	TMUSM15A	-	20.4	12.7	41.1	8.9

公制镀铬万向浅套筒套件:

111TMUSMA - 公制6角浅套筒套件: TMUSM5.5A至TMUSM15A(11件), 配塑料盒

106TMUSMA - 公制6角浅套筒套件: TMUSM8A, TMUSM10A, TMUSM12A至TMUSM15A(6件), 配塑料盒

109TMUMA - 公制12角浅套筒套件: TMUM5A至TMUM13A(9件), 配A265滑轨及套筒夹

专用套筒

8角方头套筒

	A	B	C	D	E
1/4"	TM408	15/32	15/32	17/32	7/8 1/4
5/8"	TM410	9/16	17/32	17/32	7/8 9/32
3/8"	TM412	21/32	5/8	17/32	7/8 5/16

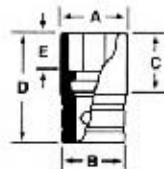

3槽套筒

#	A	B	C
#1	TTW11	15/32	15/32 7/8
#2	TTW12	7/8	15/32 7/8

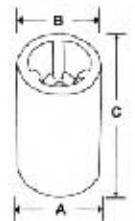

TORX® 浅套筒

#	A	B	C
E4	TLE40A	7/16	17/64 7/8
E5	TLE50A	7/16	19/64 7/8
E6	TLE60A	7/16	21/64 7/8
E7	TLE70A	7/16	23/64 7/8
E8	TLE80A	7/16	27/64 7/8
E10	TLE100A	1/2	7/16 7/8

213AFLEY - TORX® 套筒套件: 1/4" 方头TLE40A至TLE100A, 3/8" 方头FLE110A至FLE140A, 及1/2" 方头SLE160至SLE240(13件)(E4至E24), 配滑轨及套筒夹

210AFLEY - TORX® 套筒套件: 1/4" 方头TLE40A至TLE80A, 3/8" 方头FLE100A至FLE180A(10件)(E4至E18), 配A265滑轨及套筒夹

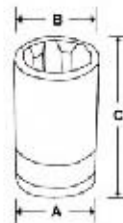

TORX® 浅套筒

此设计可以使套筒更易作用于螺钉。

#	A	B	C
E4	STLE40	15/32	9/32 2
E5	STLE50	15/32	5/16 2
E6	STLE60	15/32	11/32 2
E7	STLE70	15/32	3/8 2
E8	STLE80	15/16	13/32 2
E10	STLE100	2	7/16 2

106STLEY - TORX® 深套筒套件: STLE40至STLE100(6件)(E4至E10), 配A265滑轨及套筒夹



警告:

• 请勿将镀铬或经工业处理的手动工具应用于动力工具



套筒螺丝刀头 1/4" 方头

110ETMAY



6角套筒螺丝刀头

			A	B	B	A
1/16"	TMA2E	-	1 7/8	TMA2E2	TMAL2E2	6
5/64"	TMA2.5E	GTMA2.5E	1 7/8	TMA2.5E2	TMAL2.5E2	6
3/32"	TMA3E	GTMA3E	1 7/8	TMA3E2	TMAL3E2	6
7/64"	TMA3.5E	-	1 7/8	TMA3.5E2	TMAL3.5E2	6
1/8"	TMA4E	GTMA4E	1 7/8	TMA4E2	TMAL4E2	6
9/64"	TMA4.5E	-	1 7/8	TMA4.5E2	TMAL4.5E2	6
5/32"	TMA5E	GTMA5E	1 7/8	TMA5E2	-	-
3/16"	TMA6E	GTMA6E	1 7/8	TMA6E2	-	-
7/32"	TMA7E	GTMA7E	1 7/8	TMA7E2	-	-
1/4"	TMA8E	GTMA8E	1 7/8	TMA8E2	-	-

110ETMAY - 6角套筒螺丝刀头套件; TMA2E至TMA8E(10件), 配A265滑轨及套筒夹

212EFTAY - 组合螺丝刀头6角套筒螺丝刀头套件; 包括1/4"方头TMA2ETMA3.5E6角套筒螺丝刀头加上3/8"方头FA4E至FA12E6角套筒螺丝刀头(12件), 配A269滑轨及套筒夹

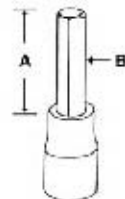

6角套筒螺丝刀头

mm		A	B
2	TMAM2E	47.8	TMAM2E2
2.5	TMAM2.5E	47.8	TMAM2.5E2
3	TMAM3E	47.8	TMAM3E2
4	TMAM4E	47.8	TMAM4E2
5	TMAM5E	47.8	TMAM5E2
6	TMAM6E	47.8	TMAM6E2

106ETMAMY - 公制6角套筒螺丝刀头套件; TMAM2E至TMAM6E(6件), 配A265滑轨及套筒夹

210EFTAMY - 组合螺丝刀头公制6角套筒螺丝刀头套件; 1/4"方头TMAM2E至TMAM3E标准长度6角套筒螺丝刀头, 及3/8"方头FAM4E至FAM10E标准长度6角套筒螺丝刀头(10件), 配A269滑轨及套筒夹



208EFTAXSY

短粗6角套筒螺丝刀头

		A	B
1/8	TMAXS4E	1 1/32	TMAXS4E2
9/64	TMAXS4.5E	1 1/16	TMAXS4.5E2
5/32	TMAXS5E	1 1/16	TMAXS5E2
3/16	TMAXS6E	1 3/32	TMAXS6E2

208EFTAXSY - 组合短粗6角套筒螺丝刀头套件; 1/4"方头TMAXS4E至TMAXS6E短粗6角套筒螺丝刀头, 3/8"方头FAXS7E至FAXS12E短粗6角套筒螺丝刀头(8件), 配A269滑轨及套筒夹

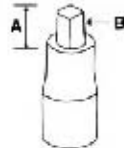
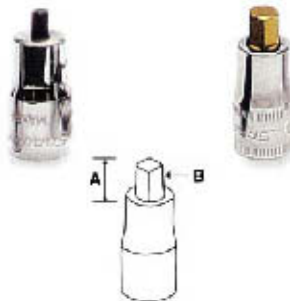

208EFTAMXSY

短粗6角套筒螺丝刀头

mm		A	B
3	TMAMXS3E	26	TMAMXS3E2
4	TMAMXS4E	27	TMAMXS4E2
5	TMAMXS5E	27	TMAMXS5E2
6	TMAMXS6E	29	TMAMXS6E2-5

208EFTAMXSY - 组合公制短粗6角套筒螺丝刀头套件; 1/4"方头TMAMXS3E至TMAMXS6E短粗6角套筒螺丝刀头, 3/8"方头FAMXS7E至FAMXS10E短粗6角套筒螺丝刀头(8件), 配A265滑轨及套筒夹



208EFTABY

球头6角套筒螺丝刀头

		A	B
1/8	TMAB4E	1 7/8	TMAB4E2
9/64	TMAB4.5E	1 7/8	TMAB4.5E2
5/32	TMAB5E	1 7/8	TMAB5E2
3/16	TMAB6E	1 15/16	TMAB6E2-2

208EFTABY - 组合方头球头6角套筒螺丝刀头套件; 1/4"方头TMAB4E至TMAB6E球头6角套筒螺丝刀头, 及3/8"方头FAB7E至FAB12E球头6角套筒螺丝刀头(8件), 配A265滑轨及套筒夹

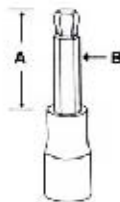
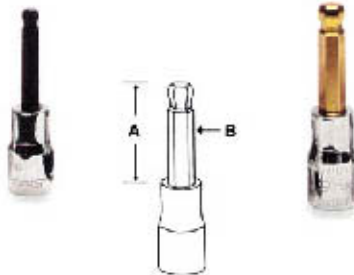

208EFTABMY

球头6角套筒螺丝刀头

mm		A	B
3	TMABM3E	47.7	TMABM3E2
4	TMABM4E	47.6	TMABM4E2
5	TMABM5E	47.9	TMABM5E2
6	TMABM6E	47.9	TMABM6E2

208EFTABMY - 组合方头公制球头6角套筒螺丝刀头套件; 1/4"方头TMABM3E至TMABM6E标准长度球头6角套筒螺丝刀头, 及3/8"方头FABM7E至FABM10E标准长度球头6角套筒螺丝刀头(8件), 配A265滑轨及套筒夹

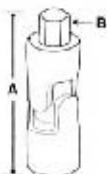

短粗万向6角套筒螺丝刀头

mm		A	B
5	TUAM5E	38.1	TUAM5E3
6	TUAM6E	38.1	TUAM6E3



1/4" 方头 套筒螺丝刀头

一字套筒螺丝刀头



#	尺寸	型号	A	B
3/16	.032	TMC104E	2 7/8	TMC104E2
1/4"	.032	TMC105E	2 15/16	TMC105E2
3/8	.042	TMC106E	2 7/8	TMC106E2

十字套筒螺丝刀头

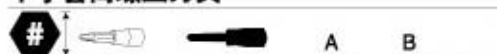

#	尺寸	型号	A	B
#0		TMP01E	1 7/8	TMP01E2
#1		TMP12E	1 7/8	TMP12E2
#2		TMP22E	1 7/8	TMP22E2

短十字套筒螺丝刀头

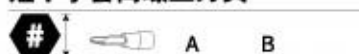

#	尺寸	型号	A	B
#2		TMP21E	1 1/4	TMP21E2
#2		TMP82E	15/16	TMP82E2

领结型套筒螺丝刀头



型号	A	B
TM27	3/16	1 3/8
TM30	1/4	1 3/8
TM31	5/32	1 3/8

长TORX® 套筒螺丝刀头

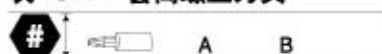

#	尺寸	型号	A	B
T8		TTXL8E	4 1/16	TTXL8E2
T10		TTXL10E	4 1/16	TTXL10E2
T15		TTXL15E	4 1/16	TTXL15E2
T20		TTXL20E	4 1/16	TTXL20E2
T25		TTXL25E	4 1/16	TTXL25E2

209EFTXBY



重型可移组合方头TORX® 套筒螺丝刀头



#	尺寸	型号	A	B
T15		TTXB15E	1 9/16	TTXB15E2
T20		TTXB20E	1 9/16	TTXB20E2
T25		TTXB25E	1 9/16	TTXB25E2

209EFTXBY - 重型可移组合方头TORX® 套筒螺丝刀头套件: 1/4" 方头TTXB15E至TTXB25E TORX 套筒螺丝刀头, 及3/8" 方头FTXR27E至FTXR50E TORX 套筒螺丝刀头(9件), 配A265滑轨及套筒夹

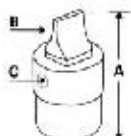
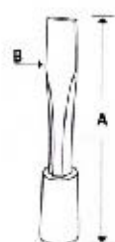

短一字套筒螺丝刀头



#	尺寸	型号	A	B	C
1/4"	.036	TM82	7/8	TM82-2C	ESD303

长十字套筒螺丝刀头

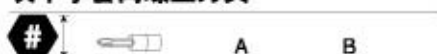

#	尺寸	型号	A	B
#2		TMP23E	3 1/16	TMP23E2

107ETTXY

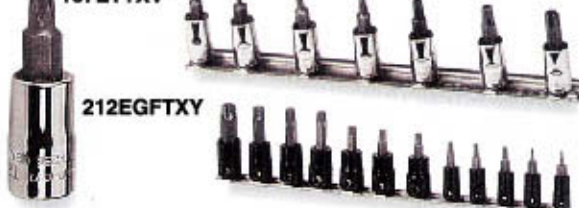

212EGFTXY



TORX® 套筒螺丝刀头

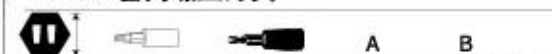

#	尺寸	型号	A	B
T8		TTX8E	1 9/16	TTX8E2
T10		TTX10E	1 9/16	TTX10E2
T15		TTX15E	1 9/16	TTX15E2
T20		TTX20E	1 9/16	TTX20E2
T25		TTX25E	1 9/16	TTX25E2
T27		TTX27E	1 9/16	TTX27E2
T30		TTX30E	1 9/16	TTX30E2
T40		TTX40E	1 9/16	TTX40E2

107ETTXY - TORX® 套筒螺丝刀头套件: TTX8E至TTX40E(TTX25E除外)(7件), 配A265滑轨及套筒夹
 212EFTXY - 组合螺丝刀头TORX® 套筒螺丝刀头套件: 1/4" 方头TTX8ETT25ETORX 套筒螺丝刀头, 3/8" 方头FTX27E至FTX55E TORX 套筒螺丝刀头, 及FTX500ETORX 套筒螺丝刀头(12件), 配A269滑轨及套筒夹
 212EGFTXY - 工业处理组合螺丝刀头TORX® 套筒螺丝刀头套件: 1/4" 方头GTTX8E至GTTX25ETORX 套筒螺丝刀头, 3/8" 方头GFTX27E至GFTX55ETORX 套筒螺丝刀头, 及GFTX500ETORX 套筒螺丝刀头(12件), 配A269滑轨及套筒夹



210EFTXRY

抗损TORX® 套筒螺丝刀头

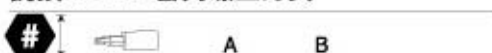

#	尺寸	型号	A	B
T8		TTXR8E	1 9/16	TTXR8E2
T10		TTXR10E	1 9/16	TTXR10E2
T15		TTXR15E	1 9/16	TTXR15E2
T20		TTXR20E	1 9/16	TTXR20E2
T25		TTXR25E	1 9/16	TTXR25E2

210EFTXRY - 抗损坏组合方头TORX® 套筒螺丝刀头套件: 1/4" 方头TTXR8E至TTXR25ETORX 套筒螺丝刀头, 3/8" 方头FTXR27E至FTXR50E TORX® 套筒螺丝刀头(10件), 配A265滑轨及套筒夹



警告:

• 请勿将镀铬或经工业处理的手动工具应用于动力工具



机用套筒

机用浅套筒



mm	6	A	B	C	D	E
3/16	GM6B	11/32	15/32	17/32	7/8	1/8
1/4	GM8B	7/16	15/32	17/32	7/8	5/32
5/16	GM10B	21/32	1/2	13/32	7/8	3/16
11/32	GM11B	15/32	17/32	13/32	7/8	3/16

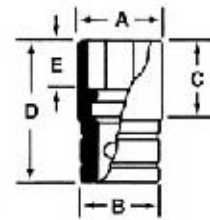

机用浅套筒

mm	6	A	B	C	D	E
5.5	GMM5.5	8.8	12.4	10.1	22.2	3.6
8	GMM8	11.8	12.4	10.1	22.2	4.3
10	GMM10	14.0	14.0	10.1	22.2	5.1



机用深套筒

mm	6	A	B	C	D	E
10	GSMM10	14	14	38.1	50.8	5.3

磁性机用套筒

磁性机用浅套筒

mm	6	A	B	D	E
1/4	MGM8D	7/16	1/2	7/8	3/32
5/16	MGM10C	1/2	1/2	15/16	3/32
11/32	MGM11	17/32	17/32	15/16	3/32
3/8	MGM12C	9/16	19/32	15/16	1/8
7/16	MGM14C	11/16	11/16	15/16	1/8
1/2	MGM16	3/4	3/4	15/16	1/8



磁性机用浅套筒

mm	6	A	B	D	E
5.5	MGMM5.5	9.9	12.4	22.2	1.9
7	MGMM7	11.9	14.0	22.2	2.0
8	MGMM8	12.7	14.0	22.2	2.4
10	MGMM10	14.8	14.8	23.8	3.1



新式装载弹簧设计不仅螺钉间隙合适，而且保证了机用。磁性套筒装载弹簧的力度比常规设计高出15倍。



磁性弹簧深套筒

mm	6	A	B	D	E
1/4	MGMS8A	3/8	7/16	2	3/32
5/16	MGMS10A	3/8	15/32	2	5/16



磁性弹簧深套筒

mm	6	A	B	D	E
7	MGMS7A	10.7	12.4	50.8	5.8
8	MGMS8A	11.8	12.4	50.8	5.8
10	MGMS10A	14.1	14.1	50.8	6.4
11	MGMS11B	15.6	15.6	50.8	6.4
12	MGMS12B	16.8	16.8	50.8	7.1
13	MGMS13A	18.1	18.1	50.8	7.6

106MGMS - 6角深套筒套件: MGMS7A至MGMS13A(6件)

机用螺丝刀头及配件



TORX® 机用螺丝刀头套筒

#	A	B
T20	PTTX20E	1 9/16 TTX20E2
T25	PTTX25E	1 9/16 TTX25E2



旋转球万向接头

可由锁定钮机械锁定

	A	B
IPM80A	5/8	1 3/8



6角转套筒接头

6角尺寸1/4", 长1" 日本气枪专用

	A	B
GMB3042	防滑球	2
GM3042A	锁定钮	2
GM3043	锁定钮	4
GM3046	锁定钮	6

210EPTXY - 组合螺丝刀头TORX®套筒螺丝刀头套件: 1/4"方头PTTX15E至PTTX25E TORX®套筒螺丝刀头、3/8"方头PFTX27E至PFTX40E TORX®套筒螺丝刀头, 及1/2"方头PSTX45E, PSTX50E, PSTX55E, PSTX500E TORX®套筒螺丝刀头(10件), A269滑轨及套筒夹

1/4" 方头

专用冲击套筒

螺旋浅套筒

		A	B	C
5/16	TSTY101A	1/2	1/2	7/8
3/8	TSTY121A	9/16	9/16	7/8
7/16	TSTY141A	21/32	21/32	1
1/2	TSTY161A	23/32	23/32	1
9/16	TSTY181A	13/16	13/16	1 1/32

105TSTSYA: TSTSY101A至TSTSY181A(5件)

螺旋深套筒

		A	B	C
5/16	TSTSY101A	1/2	1/2	2
3/8	TSTSY121A	9/16	9/16	2
7/16	TSTSY141A	21/32	21/32	2
1/2	TSTSY161A	23/32	23/32	2
9/16	TSTSY181A	13/16	13/16	2

105TSTSYA: TSTSY101A至TSTSY181A(5件)

螺旋浅套筒

mm		A	B	C
6	TSTY6A	12.1	10.2	22.2
8	TSTY8A	12.7	12.7	22.2
10	TSTY10A	15.2	15.2	22.2
12	TSTY12A	17.3	17.3	25.4
14	TSTY14A	20.5	20.5	26.2

105TSTSMYA: TSTSY6A至TSTSY14A(5件)

螺旋深套筒

mm		A	B	C
6	TSTSY6A	12.1	10.2	50.8
8	TSTSY8A	12.7	12.7	50.8
10	TSTSY10A	15.2	15.2	50.8
12	TSTSY12A	17.3	17.3	50.8
14	TSTSY14A	20.5	20.5	50.8

105TSTSMYA: TSTSY6A至TSTSY14A(5件)

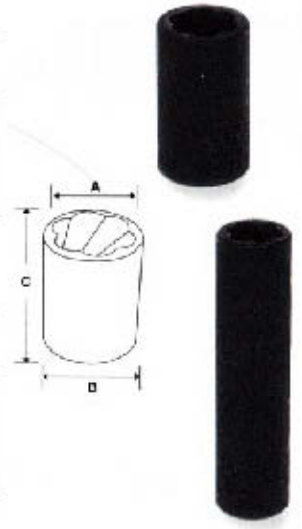

FLANK DRIVE® 冲击套筒

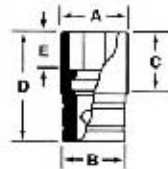
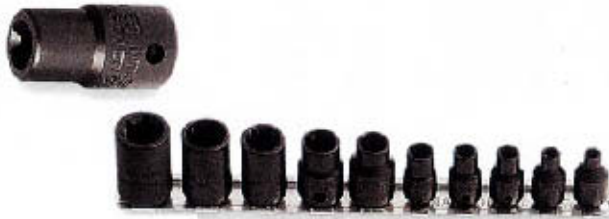

TORX® 冲击浅套筒

#		A	B	C	D	E
E5	IMTLE50A	5/16	1/2	17/32	7/8	3/16
EE8	IIMTLE80A	7/16	1/2	17/32	7/8	1/4

210IMFLEYA: 1/4" 方头IMTLE40A至IMTLE80A套筒, 及3/8" 方头IMFLE100A套筒(10件), 配A265滑轨及套筒夹

冲击浅套筒

		A	B	C	D	E
1/4	IMTM8A	13/32	1/2	17/32	7/8	1/4
5/16	IMTM10A	1/2	1/2	17/32	7/8	1/4
3/8	IMTM12A	9/16	1/2	17/32	7/8	1/4
7/16	IMTM14A	21/32	1/2	17/32	7/8	1/4
1/2	IMTM16A	23/32	1/2	17/32	7/8	9/32
9/16	IMTM18A	13/16	1/2	9/16	29/32	11/32



冲击浅套筒

mm		A	B	C	D	E
5	IMTMM5	8.5	12.1	13.1	22.2	4.1
5.5	IMTMM5.5	9.3	12.1	13.1	22.2	4.1
6	IMTMM6	10.2	12.1	13.1	22.2	6.1
7	IMTMM7	11.5	12.1	13.1	22.2	6.1
8	IMTMM8	12.7	12.7	13.1	22.2	6.1
9	IMTMM9	14.0	14.0	13.1	22.2	6.1
10	IMTMM10	15.2	15.2	13.0	22.2	6.1
11	IMTMM11	16.4	16.4	12.8	22.2	6.4
12	IMTMM12	17.3	17.3	12.7	22.2	7.1
13	IMTMM13	18.7	18.7	12.5	22.2	7.4
14	IMTMM14	20.3	20.3	13.1	23.3	8.6
15	IMTMM15	21.1	21.1	13.9	23.8	8.9

112IMTMMY - 公制6角冲击浅套筒套件: IMTMM5至IMTMM15(12件), 配A269滑轨及套筒夹

半深冲击套筒

		A	B	C	D	E
1/4	IMTMS8	13/32	15/32	29/32	1 1/4	1/4
5/16	IMTMS10	1/2	1/2	3/4	1 1/4	1/4
3/8	IMTMS12	9/16	9/16	3/4	1 1/4	1/4
7/16	IMTMS14	21/32	21/32	3/4	1 1/4	1/4
1/2	IMTMS16	11/16	11/16	3/4	1 1/4	9/32
9/16	IMTMS18	13/16	13/16	3/4	1 1/4	11/32

106IMTMSY - 6角半深冲击套筒套件: IMTMS8至IMTMS18(6件), 配A265滑轨及套筒夹



警告:

- 请勿将镀铬或经工业处理的手动工具应用于机用工具
- 万向接头在使用中请勿触摸



FLANK DRIVE® 冲击套筒

1/4" 方头

半深冲击套筒

mm	6	A	B	C	D	E
5	IMTMMS5	8.5	12.1	22.9	31.8	4.1
5.5	IMTMMS5.5	9.3	12.1	22.9	31.8	4.1
6	IMTMMS6	10.2	12.1	22.9	31.8	6.1
7	IMTMMS7	11.5	12.1	22.9	31.8	6.1
8	IMTMMS8	12.7	12.7	19.1	31.8	6.1
9	IMTMMS9	14.0	14.0	19.3	31.8	6.1
10	IMTMMS10	15.2	15.2	19.3	31.8	6.1
11	IMTMMS11	16.4	16.4	19.3	31.8	6.4
12	IMTMMS12	17.3	17.3	19.3	31.8	7.1
13	IMTMMS13	18.7	18.7	19.3	31.8	7.4
14	IMTMMS14	20.3	20.3	19.3	31.8	8.6
15	IMTMMS15	21.1	21.1	19.3	31.8	8.9

112IMTMMSY - 公制6角半深冲击套筒套件: IMTMMS5至IMTMMS15(12件)
A269滑轨及套筒夹

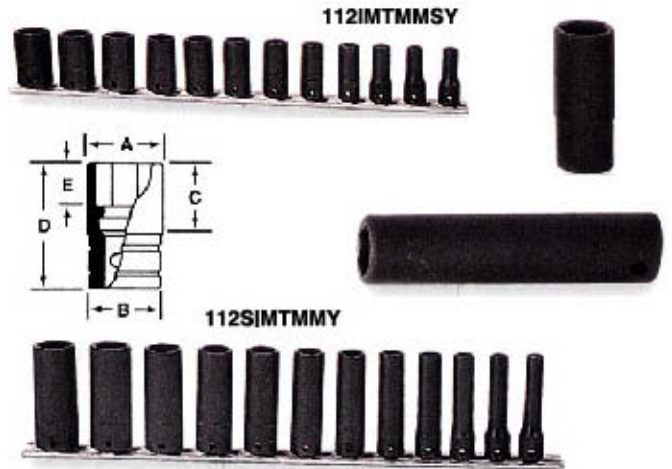

106SIMTMY



冲击深套筒

1/4"	6	A	B	C	D	E
1/4	SIMTMM8	13/32	15/32	1 1/2	2	1/4
5/16	SIMTMM10	1/2	1/2	1 1/2	2	1/4
3/8	SIMTMM12	9/16	9/16	1 1/2	2	1/4
7/16	SIMTMM14	21/32	21/32	1 1/2	2	1/4
1/2	SIMTMM16	11/16	11/16	1 1/2	2	9/32
9/16	SIMTMM18	13/16	13/16	1 1/2	2	11/32

106SIMTMY - 6角冲击深套筒套件: SIMTMM8至SIMTMM18(6件) A265滑轨及套筒夹

冲击深套筒

mm	6	A	B	C	D	E
5	SIMTMM5	8.5	12.1	41.9	50.8	4.1
5.5	SIMTMM5.5	9.3	12.1	41.9	50.8	4.1
6	SIMTMM6	10.2	12.1	41.9	50.8	6.1
7	SIMTMM7	11.5	12.1	41.9	50.8	6.1
8	SIMTMM8	12.7	12.7	41.9	50.8	6.1
9	SIMTMM9	14.0	14.0	41.9	50.8	6.1
10	SIMTMM10	15.2	15.2	41.9	50.8	6.1
11	SIMTMM11	16.4	16.4	41.9	50.8	6.4
12	SIMTMM12	17.3	17.3	41.9	50.8	7.1
13	SIMTMM13	18.7	18.7	41.9	50.8	7.4
14	SIMTMM14	20.3	20.3	41.9	50.8	8.6
15	SIMTMM15	21.1	21.1	41.9	50.8	8.9

112SIMTMMY - 公制6角冲击深套筒套件: SIMTMM5至SIMTMM15(12件),
A269滑轨及套筒夹

FLANK DRIVE® 旋转冲击套筒



旋转冲击浅套筒

mm	6	A	B	D	E
5	IPTMM5	8.4	15.4	35.4	4.1
5.5	IPTMM5.5	9.3	15.4	35.8	4.1
6	IPTMM6	10.3	15.4	36.2	4.1
7	IPTMM7	11.5	15.4	37.4	4.3
8	IPTMM8	12.7	15.4	38.6	4.8
9	IPTMM9	14.0	15.4	39.8	5.3
10	IPTMM10	15.2	15.4	41.0	5.8
11	IPTMM11	16.4	15.4	42.5	6.4
12	IPTMM12	17.3	17.9	44.9	6.9
13	IPTMM13	18.7	17.9	46.1	7.4
14	IPTMM14	20.3	17.9	47.7	7.9
15	IPTMM15	21.1	17.9	48.1	7.9

112IPTMMY - 公制6角旋转冲击浅套筒套件: IPTMM5至IPTMM15(12件)
A269滑轨及套筒夹



旋转冲击浅套筒

1/4"	6	A	B	D	E
1/4	IPTM8	13/32	19/32	1 13/32	5/32
5/16	IPTM10	1/2	19/32	1 1/2	3/16
3/8	IPTM12	9/16	19/32	1 19/32	7/32
7/16	IPTM14	21/32	19/32	1 11/16	1/4
1/2	IPTM16	23/32	23/32	1 13/16	5/16
9/16	IPTM18	13/16	23/32	1 7/8	5/16

106IPTMY 6角旋转冲击浅套筒套件: IPTM8至IPTM18(6件)
A265滑轨及套筒夹

冲击附件



旋转球万向接头

防滑球采用防磨损设计

	A	B
IPM800A	5/8	1 3/8



3/8" 方头 常用基本套件

按需组合套件!

206AFSP—手柄套件是“按需组合套件”的理想基础。用户可以加入任何推荐的套筒套件，或是从专用套筒中自由选择。206AFSP套件存放于PB16B塑料盒中，塑料盒有足够空间放置4排标准套筒套件、2排深套筒套件或万向套筒套件，或是这些套筒套件的组合。

206AFSP—手柄套件

F936密封头棘轮扳手、FU8A万向接头、FX1延长杆、FXK3—3" 凸边延长杆、FXK6—6" 凸边延长杆、及FXK11—11" 凸边的延长杆(6件)，配PB16B塑料盒

建议附加件(英制):

211FSY	6角浅套筒套件
212FY	6角浅套筒套件
211SFSY	6角深套筒套件
211SFY	12角浅套筒套件
207FSU	6角万向深套筒套件
211FDSY	12角半深套筒套件

建议附加件(公制):

211FSMY	6角浅套筒套件
212SFSMY	6角半深套筒套件
212SFMY	12角深套筒套件
212FSMSY	6角半深套筒套件
212FMSY	12角半深套筒套件
212FMY	12角浅套筒套件



PALMRATKIT



PALMRATKIT(6件)

PALMRAT	手掌式棘轮扳手
FXWK3	活动延长杆
F121	12角浅套筒, 3/8"
F161	12角浅套筒, 1/2"
F181	12角浅套筒, 9/16"
FM8	12角浅套筒, 8mm
FM10	12角浅套筒, 10mm

盒中预留有扩充位置

FM12	12角浅套筒, 12mm
FBSM8A	磁性套筒头
SDM213B	一字螺丝刀头
SDM211B	一字螺丝刀头
SDM221IRB	#1十字螺丝刀头
SDM222IB	#2十字螺丝刀头

冲击螺丝刀头套件

PIT2230E套件(36件):



PIT2230E

PIT120	冲击螺丝刀头
FA6E	3/16" 内6角套筒螺丝刀头, 带加强FA6E2
FA7E	7/32" 内6角套筒螺丝刀头, 带加强FA7E2
FA8E	1/4" 内6角套筒螺丝刀头, 带加强FA8E2
FA10E	5/16" 内6角套筒螺丝刀头, 带加强FA10E2
FA12E	3/8" 内6角套筒螺丝刀头, 带加强FA12E2-5
F42E	1/4" 一字螺丝刀头, 带加强F42E2
F52E	5/16" 一字螺丝刀头, 带加强F52E2
F62E	3/8" 一字螺丝刀头, 带加强F62E2
FP22E	#2十字螺丝刀头, 带加强FP22E2
FP32E	#3十字螺丝刀头, 带加强FP32E2
FP41E	#4十字螺丝刀头, 带加强FP41E2-5
FP42E	#4十字螺丝刀头, 带加强FP42E2

F29A	3/8" 领结形套筒螺丝刀头
F30	5/16" 领结形套筒螺丝刀头
FDP22E	#2 POZIDRIV® 螺丝刀头
IMF120A	6角冲击套筒, 3/8"
IMF140A	6角冲击套筒, 7/16"
IMF160	6角冲击套筒, 1/2"
IMF180	6角冲击套筒, 9/16"
IMF200	6角冲击套筒, 5/8"
IMF220	6角冲击套筒, 11/16"
IMF240	6角冲击套筒, 3/4"
GF22	扁头套筒, 11/16"
KRA142	金属盒

208EPIT套件(8件)

PIT120	冲击螺丝刀头
F42E	1/4" 一字螺丝刀头
F52E	5/16" 一字螺丝刀头
F62E	3/8" 一字螺丝刀头
FP22E	#2十字螺丝刀头
FP32E	#3十字螺丝刀头
FP42E	#4十字螺丝刀头
FDP22E	#2 POZIDRIV® 螺丝刀头
PB108	塑料盒



208EPIT



PIT120冲击把

使用锤子紧/松紧固件时, 可以传递凸轮冲击效应, 经工业处理。



警告:

• 请勿将镀铬或经工业处理的手动工具应用于动力工具



英制6角套件

常用套件 3/8" 方头

210AFSP



210AFSP—6角常用套件(10件)

6角浅套筒

FS121	3/8"	FS201	5/8"
FS141	7/16"	FS221	11/15"
FS161	1/2"	FS241	3/4"
FS181	9/16"		

还包括:

F936	标准手柄密封棘轮扳手
FXK3	3" 延长杆
FXK6	6" 延长杆

218AFSP—6角常用套件(18件)

6角浅套筒

FS081	1/4"	FS201	5/8"
FS101	5/15"	FS221	11/16"
FS121	3/8"	FS241	3/4"
FS141	7/16"	FS261	13/16"
FS161	1/2"	FS281	7/8"
FS181	9/16"		

还包括:

F936	标准手柄密封棘轮扳手	FU8A	万向接头
F4LB	快卸手柄	FXK3	3" 延长杆
F10LC	变向手柄	FXK6	6" 延长杆
		FXK11	11" 延长杆

222AFSP—6角常用套件(22件)

6角浅套筒

FS121	3/8"	SFS121	3/8"
FS141	7/16"	SFS141	7/16"
FS161	1/2"	SFS161	1/2"
FS181	9/16"	SFS181	9/16"
FS201	5/8"	SFS201	5/8"
FS221	11/16"	SFS221	11/15"
FS241	3/4"	SFS241	3/4"

6角深套筒

还包括:

F936	标准手柄密封棘轮扳手
S9704KA	6角火花塞套筒
S9706KA	6角火花塞套筒
F10LC	变向手柄
FU8A	万向接头
FXK3	3" 延长杆
FXK4	4" 延长杆
FXK8	8" 延长杆
PB17B	塑料盒

222AFSP



英制12角套件

218FPB



218FPB—12角常用套件(18件)

12角浅套筒

F081	1/4"	F201	5/8"
F101	5/15"	F221	11/16"
F121	3/8"	F241	3/4"
F141	7/16"	F261	13/16"
F161	1/2"	F281	7/8"
F181	9/16"		

还包括:

F936	标准手柄密封棘轮扳手
F4LB	快卸手柄
F10LC	变向手柄
FU8A	万向接头

FXK3	3" 延长杆
FXK6	6" 延长杆
FXK11	11" 延长杆
KRA284B	金属盒

218AFP—12角常用套件(仅含工具)

除没有KRA284B金属盒外, 其余部件与218FPB套件相同

248FB—12角套件(48件)

12角浅套筒

F081	1/4"	SF081	1/4"	FU10A	5/16"
F101	5/16"	SF101	5/16"	FU12A	3/8"
F111	11/32"	SF121	3/8"	FU14A	7/16"
F121	3/8"	SF141	7/16"	FU16A	1/2"
F141	7/16"	SF161	1/2"	FU18A	9/16"
F161	1/2"	SF181	9/16"	FU20A	5/8"
F181	9/16"	SF201	5/8"	FU22A	11/16"
F201	5/8"	SF221	11/16"	FU24A	3/4"
F221	11/16"	SF241	3/4"	FU26A	13/16"
F241	3/4"	SF261	13/16"	FU28A	7/8"
F261	13/16"	SF281	7/8"	FU30A	15/16"
F281	7/8"			FU32A	1"

12角深套筒

12角万向套筒

还包括:

F936	标准手柄密封棘轮扳手	F40B	短手柄驱动把	FXK4	4" 延长杆
F4LB	快卸摇把	FRS70A	棘轮旋转头	FXK6	6" 延长杆
F5L	滑动T型扳手	F67B	棘轮转接头	FXK11	11" 延长杆
F10LC	变向手柄	FU8A	万向接头	FX61A	可弯曲延长杆
		FXK3	3" 延长杆	KRA250B	金属盒

248FBP



248F—12角常用套件(仅含工具)

除没有KRA250金属盒外, 其余部件与248FB套件相同

3/8" 方头 常用套件

英制6/12角套件

292FB—英制6/12角常用套件(92件)

6角浅套筒(11件)
6角深套筒(11件)
12角深套筒(11件)
12角浅套筒(12件)
12角万向套筒(12件)

还包括:

F936 标准手柄密封棘轮扳
FLF936 密封翻转棘轮扳手
F4LB 快卸摇把
F5L 滑动T型扳手
F10LC 变向手柄
F40B 短手柄驱动把
FRS70A 棘轮旋转头
F67B 棘轮转接头
FU8A 万向接头
FX1 1 1/2" 延长杆
FXK3 3" 延长杆
FXK4 4" 延长杆
FXK6 6" 延长杆
FXK11 11" 延长杆

FX61A 可弯曲延长杆
GF22 拉杆套筒
F23E 一字套筒螺丝刀头
F25E 一字套筒螺丝刀头
F31E 一字套筒螺丝刀头
F29A 离合式套筒螺丝刀头
F30 离合式套筒螺丝刀头
FA5E 6角套筒螺丝刀头, 5/32"
FA6E 6角套筒螺丝刀头, 3/16"
FA7E 6角套筒螺丝刀头, 7/32"
FA8E 6角套筒螺丝刀头, 1/4"
FA10E 6角套筒螺丝刀头, 5/16"
FA12E 6角套筒螺丝刀头, 3/8"



FP22E #2十字套筒螺丝刀头
FP32E #3十字套筒螺丝刀头
FP42E #4十字套筒螺丝刀头
PP409A 管道塞套筒, 9/32"
PP410A 管道塞套筒, 5/16"
PP412A 管道塞套筒, 3/8"
S9704KFUA 火花塞万向套筒, 13/16"
KRA250B 金属盒

292F—英制6/12角常用套件(仅含工具)

除没有KRA250B金属盒外, 其余部件与292FB套件相同

公制6角套件

222AFSMP—公制6角常用套件(22件)

6角浅套筒		6角深套筒	
FSM101	10mm	SFSM101	10mm
FSM111	11mm	SFSM111	11mm
FSM131	13mm	SFSM131	13mm
FSM141	14mm	SFSM141	14mm
FSM151	15mm	SFSM151	15mm
FSM171	17mm	SFSM171	17mm
FSM191	19mm	SFSM191	19mm

还包括:

F936 标准手柄密封棘轮扳
FU8A 万向接头
F10LC 变向手柄
FXK3 3" 延长杆
FXK4 4" 延长杆
FXK8 8" 延长杆
S9704KA 火花塞套筒, 13/16"
S9706KA 火花塞套筒, 5/8"
PB17B 塑料盒



公制6/12角套件

262MFB 6/12角公制常用套件(62件)

6角浅套筒		12角浅套筒		12角深套筒		6角万向浅套筒	
FSM81	8mm	FM9	9mm	SFM	8mm	FSUM7	7mm
FSM91	9mm	FM10	10mm	SFM9	9mm	FSUM8	8mm
FSM101	10mm	FM11	11mm	SFM10	10mm	FSUM10	10mm
FSM111	11mm	FM12	12mm	SFM11	11mm	FSUM11	11mm
FSM121	12mm	FM13	13mm	SFM12	12mm	FSUM12	12mm
FSM131	13mm	FM14	14mm	SFM13	13mm	FSUM13	13mm
FSM141	14mm	FM15	15mm	SFM14	14mm	FSUM14	14mm
FSM151	15mm	FM16	16mm	SFM15	15mm	FSUM15	15mm
FSM161	16mm	FM17	17mm	SFM16	16mm	FSUM16	16mm
FSM171	17mm	FM18	18mm	SFM17	17mm	FSUM17	17mm
FSM181	18mm	FM19	19mm	SFM18	18mm	FSUM18	18mm
FSM191	19mm			SFM19	19mm	FSUM19	19mm
						FSUM21	21mm
						FSUM22	22mm
						FSUM24	24mm

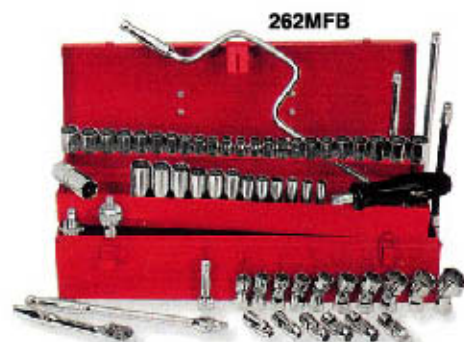

还包括:

F936 标准手柄密封棘轮扳
F4LB 快卸摇把
F10LC 变向手柄
F40B 短手柄驱动把
FRS70A 棘轮旋转头
F67B 棘轮转接头
FU8A 万向接头
FXK3 3" 延长杆
FXK6 6" 延长杆
FXK11 11" 延长杆
FX61A 可弯曲延长杆
S9704KA 火花塞套筒, 13/16"
KRA250B 金属盒



警告:



• 请勿将镀铬或经工业处理的手动工具应用于动力工具

棘轮扳手 3/8" 方头

高强度密封棘轮扳手

专利设计，内部扩孔，采用高科技技术密封。特殊的O型环不仅可永久密封并润滑油，还可阻挡灰尘、污垢、湿气和其他污染物。便于使用，无需日常维护。美国专利号：4,934,220 和 6,125,722。

圆头棘轮扳手

外型细长，可在狭窄区域内正常工作。72齿棘轮头。

多向头棘轮扳手

多功能。棘轮头定位方向达17个。按动头部下方的控定机构，便可使头部在“锁定位”或“未锁定位”。开关按钮用一只手指就可操控。即使在狭窄的工作区域，只要头部在“未锁定位”，仅需简单推/拉的动作即可使工具更称手。360°曲柄运动可增强棘轮效应。棘轮最小工作角度为6°，对工作空间的要求较小。头部密封于石墨油中，可阻挡灰尘、污垢、湿气和其他污染物。美国专利号：5,419,221和5,495,783。

高强度密封棘轮扳手



圆头棘轮扳手

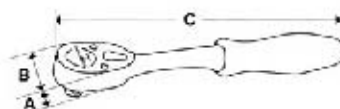

高强度密封棘轮扳手		圆头棘轮扳手		密封		密封/冲击		密封/快卸		圆头	
型号	手柄	手柄	手柄	密封	密封/冲击	密封/快卸	圆头	A	B	C	零件号
F936	▲ ■	GF936	标准手柄	密封	36	10°	5/8	1 5/32	7 11/32		RKRF936
FK936		-	短手柄	密封	36	10°	5/8	1 5/32	4 5/32		RKRF936
FL936		GFL936	长手柄	密封	36	10°	5/8	1 5/32	10 5/16		RKRF936
FLF936	▲	GFLF936	可翻转长手柄	密封	36	10°	5/8	1 5/32	11 1/2		RKRF936
FKF936	▲	-	可翻转短手柄	密封	36	10°	5/8	1 5/32	4 3/4		RKRF936
FBF936	▲	-	带倾角可翻转手柄	密封	36	10°	5/8	1 5/32	11 1/8		RKRF936
FSLF936	▲	-	快卸可翻转手柄	密封	36	10°	5/8	1 5/32	13 3/4		RKRF936
F936FOD		-	标准手柄(FOD型)	密封	36	10°	5/8	1 5/32	7 11/32		-
FC936	▲	-	短手柄	密封/冲击	36	10°	7/16	7/8	4 7/16		RKRFC936
FCF936	▲	-	可翻转手柄	密封/冲击	36	10°	7/16	7/8	6 1/8		RKRFC936
FX936		-	可锁定翻转手柄	密封	36	10°	9/16	1 5/32	11 1/4		RKRF936
FR936	▲	-	标准手柄	密封/快卸	36	10°	5/8	1 5/32	7 11/32		RKRFR936
F872	▲	-	标准手柄	圆头	72	5°	9/16	1 1/4	7 19/32		RKRF872B

■ 航空标准：AS4283 Rev-A

▲ ASME/ANS/B107.10M-1996

3/8" 方头 棘轮扳手

舒适手柄棘轮扳手



						H	W	L	
FH936A	标准手柄	密封头	红(软手柄)	36	10°	5/8	1 5/32	9 9/16	RKRF936
FHL936A	长手柄	密封头	红(软手柄)	36	10°	5/8	1 5/32	12 1/2	RKRF936
FHF936A	可翻转手柄	密封头	红(软手柄)	36	10°	5/8	1 5/32	9 9/16	RKRF936
FHLF936A	可翻转长手柄	密封头	红(软手柄)	36	10°	5/8	1 5/32	13 5/8	RKRF936
FHBF93A	带倾角可翻转手柄	密封头	红(软手柄)	36	10°	5/8	1 5/32	13 5/16	RKRF936
FH747	可翻转手柄	圆头	红(软手柄)	49	7°	11/16	1 3/4	12 3/4	RKRF749

专用棘轮扳手

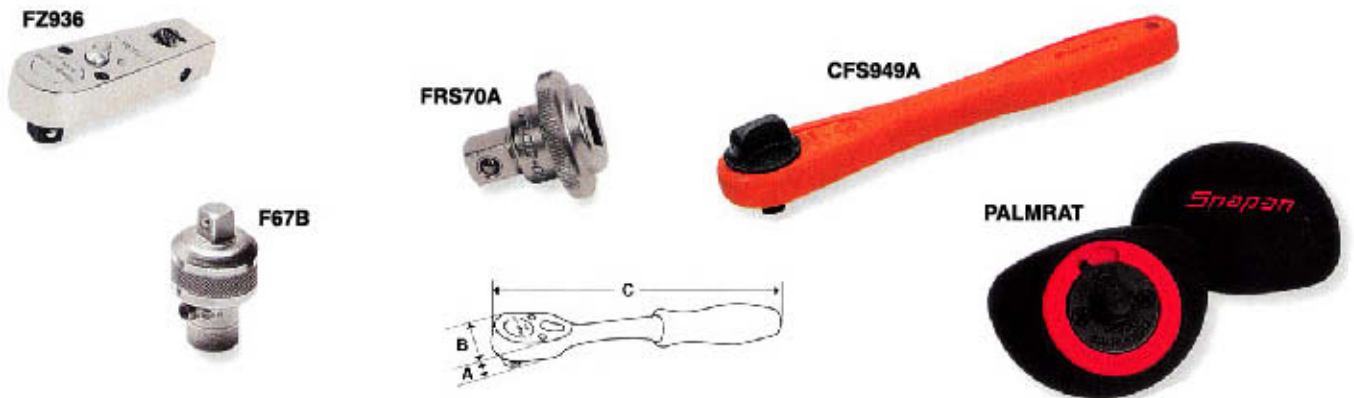

						A	B	C	
FZ936	—	多用	密封	—	36	10°	5/8	3 1/16	RKRF936
FRS70A	—	旋式棘轮头	—	—	—	1 9/32	—	1 1/4	—
F67B	GF67B	棘轮转接头	—	—	20	18°	11/16	2 1/16	—
PALMRAT	—	手掌式	—	黑色	20	18°	1 3/16	2 5/8	RKRFPALMRAT
CFS949A	—	复合材料(绝缘)	圆头	橙色	49	7.3°	1 1/4	8 3/4	RKRCFS949A

警告:

- 请勿将镀铬或经工业处理的手动工具应用于动力工具
- 时常检查、清理并用轻质油润滑棘轮机械装置部分

警告:

- 使用工具箱内的全套部件。不要个别替换零件
- 万向接头在使用中请勿触摸



棘轮扳手套件



RAT603A—棘轮扳手套件

F936标准手柄, FL936长手柄, 及FLF936可翻转长手柄头密封棘轮扳手(3件), 配塑料盒

RAT936—棘轮扳手套件

1/4" 方头T936, 3/8" F936和1/2" S936(3件), 配塑料盒

专用棘轮扳手套件

PALMRATKIT



盒中预留有扩充位置

PALMRATKIT(13件)

- PALMRAT 手掌式棘轮扳手
- FXWK3 3' 摇动方头延长杆
- F121 12角浅套筒, 3/8"
- F161 12角浅套筒, 1/2"
- F181 12角浅套筒, 9/16"
- FM8 12角浅套筒, 8mm
- FM10 12角浅套筒, 10mm
- FM12 12角浅套筒, 12mm
- FBSM8A 磁性套筒头
- SDM213B 一字螺丝刀头
- SDM211B 一字螺丝刀头
- SDM221IRB #1十字螺丝刀头
- SDM222IRB #2十字螺丝刀头

附件



F40B



SGF50

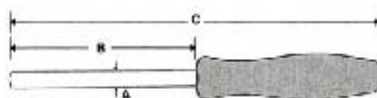

塑料手柄棘轮扳手



		A	B	C
F40B	塑料手柄	1/2	1	5 15/16
SGF50	软手柄	1/2	3 3/32	8

• 含一个3/8"内部驱动方头, 可用作延长杆。



F50A



FX62B



F4LB



F4LBK



GF4LB

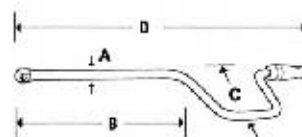

快卸棘轮扳手

	A	B	C	D
F4LB	13/32	7 7/8	3 1/2	17 27/32
F4LBK*	13/32	7 7/8	3 1/2	16 5/8

• 球状握手

3/8" 方头 棘轮扳手配件

变向手把



	A	C	B
F10LC	3/4	15/32	9 9/16
FHBB12	13/16	15/32	13



滑动T形扳手

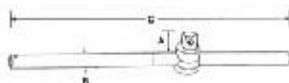

	A	B	C
F5L	3/4	13/32	8

棘轮转接头

206EAU—转接头/延长杆套件:

TM1和A2A转接头、FU8A方向接头和FX1、FXK3及FXK6延长杆(6件), 配塑料盘

	A	B	C
—	3/8	1/4	1 1/8
TA3	1/4	3/8	15/16
A2A	3/8	1/2	1 5/16
—	1/2	3/8	1 1/2



1206GS—组合方头转接头套件

1/4" 方头GFAT1E和TA3转接头、3/8" 方头A2A和GSAF1E转接头、及1/2" 方头GLA12B和GLA62转接头(6件), 配滑轨及套筒夹



磁性转接头

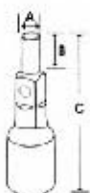

	A	B	C
FXM112	5/16	9/32	1 25/32
FXM18	3/16	9/32	1 25/32



206XMSP—磁性转接头套件

1/4" 方头TMXM17和TMXM114转接头、3/8" 方头FXM18和FXM112转接头、及1/2" 方头SXM212和SXM222转接头(6件), 配滑轨及套筒夹



延长转接头

	A	B	C
GAX5	1/2	3/8	5
GAX12	1/2	3/8	12
GAX24	1/2	3/8	23 1/4
GAX36	1/2	3/8	36



复合材料(绝缘)转接头

每件工具都经过单独测试, 以确保可绝缘1000伏电压。这些工具已经达到或是超过欧洲标准EN60900和IEC60900关于绝缘体强度测试与设计的要求, 以及ASTM1505及VDE0680典型测试要求。同时, 还达到或是超过ASME B107.1、ISO 1711和ISO 3315标准对非绝缘钢工具的强度要求。美国专利号: 5,394,773、5,448,932及5,875,693。



	A	B	C	D
CA1MF	1/2	3/8	1 5/16	3 25/32
CA2A	3/8	1/2	1	3 7/8



警告:



- 请勿将机用套筒及其配件用于冲击工具
- 万向接头在使用中请勿触摸
- 请勿将镀铬或经工业处理的手动工具应用于动力工具
- 请勿使用损坏的工具
- 请正确使用工具
- 不正常的使用、打击、或折断工具会对人身造成伤害

万向接头

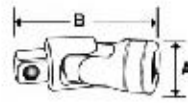

万向接头

		A	B
• FU8A	GFU8A	3/4	9 9/16
• FU80B	-	11/16	11 9/16
* FUB8A	-	1	13

* 可旋转万向接头 • ASME/ANSI B107.10M-1996
103UFTS—万向接头套件：包括1/4"方头TMU8B、3/8"方头FU8A及1/2"方头S8万向接头(3件)，配塑料盒

延长杆



防滑球延长杆

		A	B
FX1	GFX1	1/2	1 1/2
FXK3*	GFXK3*	13/32	13
FXK4*	-	13/32	4
FXK6*	GFXK6*	13/32	6
FXK8*	GFXK8*	13/32	8
FXK11*	GFXK11*	13/32	11
FX18	-	1/2	18
FX24A	-	1/2	24
FX36	-	1/2	36

* 方头端有凸边，可用方便的手指转动
208AFX—延长杆套件：FX1至FX24A(8件)，配塑料盒
206AFX—延长杆套件：FX1至FXK11(6件)，配塑料盒

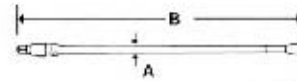

快卸可锁延长杆

可方便快捷的从延长杆上卸下套筒。方头端有凸边，可用方便的手指转动。

	A	B
FXKL3	1/2	3
FXKL6	1/2	6
FXKL11	1/2	11
FXKL24	1/2	24

204FXKL—延长杆套件：FXKL3至FXKL24(4件)，配塑料盒

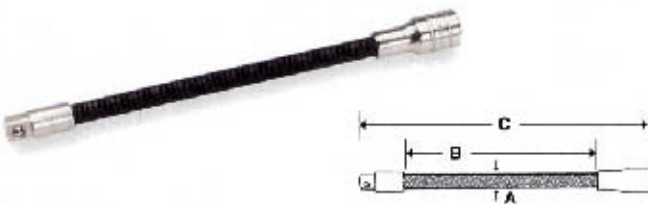
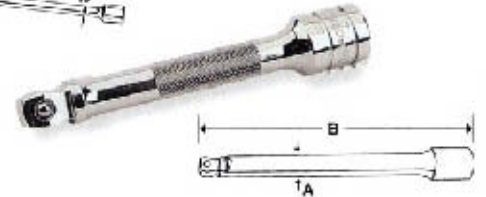

可弯延长杆

	A	B	C
FX61A	3/8	5 3/8	8

复合材料(绝缘)延长杆

每件工具都经过单独测试，以确保可绝缘1000伏电压。这些工具已经达到或是超过欧洲标准EN60900和IEC60900关于绝缘体强度测试与设计的要求，以及ASTM1505及VDE0680典型测试要求。同时，还达到或是超过ASME B107.1、ISO 1711和ISO 3315标准对非绝缘钢工具的强度要求。美国专利号：5,394,773、5,448,932及5,875,693。

	A	B	D
CFX3	3/8	2	3
CFX6	3/8	2	6

防滑球活动延长杆

	A	B
FXWP1	1/2	1 1/2
FXWP3*	13/32	3
FXWP4*	13/32	4
FXWP6*	13/32	6
FXWP8*	13/32	8
FXWP11*	13/32	11

* 有凸边
206AFXWP—活动延长杆套件：FXWP1至FXWP11(6件)，配塑料盒

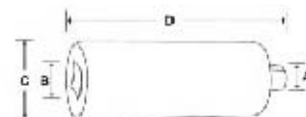

3/8" 方头 FLANK DRIVE® 套筒



浅套筒

11	6	12	6	12	A	B	C	D	E
1/4	FS081	F081	GFS081	GF081	13/32	11/16	7/16	29/32	7/32
5/16	FS101	F101	GFS101	GF101	15/32	11/16	7/16	29/32	1/4
11/32	FS111	F111	-	GF111	1/2	11/16	7/16	29/32	9/32
3/8	FS121	F121	GFS121	GF121	9/16	11/16	7/16	29/32	9/32
7/16	FS141	F141	GFS141	GF141	5/8	11/16	7/16	29/32	9/32
1/2	FS161	F161	GFS161	GF161	23/32	11/16	1/2	15/16	5/16
9/16	FS181	F181	GFS181	GF181	25/32	3/4	1/2	1 1/32	3/8
19/32	-	F191	-	GF191	13/32	25/32	9/16	1 1/16	3/8
5/8	FS201	F201	GFS201	GF201	27/32	25/32	19/32	1 3/32	1/2
11/16	FS221	F221	GFS221	GF221	15/16	7/8	5/8	1 1/8	17/32
3/4	FS241	F241	GFS241	GF241	1	15/16	11/16	1 3/16	15/32
13/16	FS261	F261	GFS261	GF261	1 1/16	1	11/16	1 7/32	1/2
7/8	FS281	F281	GFS281	GF281	1 5/32	1 1/32	23/32	1 9/32	9/16
15/16	FS301	F301	GFS301	GF301	1 1/4	1 3/16	25/32	1 11/32	9/16
1	FS321	F321	GFS321	GF321	1 5/16	1 1/4	13/16	1 3/8	19/32

镀铬6角套筒套件:

214FSY - 6角浅套筒套件: FS081至FS321(14件), 配A267滑轨及套筒夹

211FSY - 6角浅套筒套件: FS081至FS281(FS111除外)(11件), 配A269滑轨及套筒夹

镀铬浅/深套筒套件:

222SFFS - 6角浅/深套筒套件: FS081至FS281(FS111除外), 6角浅套筒加上SFS081至SFS281(SFS111除外), 6角深套筒(22件), 配塑料盘

镀铬12角套筒套件:

212FY - 12角浅套筒套件: F081至F281(F191除外)(12件), 配A269滑轨及套筒夹

211FY - 12角浅套筒套件: F081至F281(F111和F191除外)(11件), 配A269滑轨及套筒夹

工业处理6角套筒套件:

211GFSY - 工业处理6角浅套筒套件: GFS081至GFS281(11件), 配A269滑轨及套筒夹

工业处理12角套筒套件:

215GFY - 工业处理12角浅套筒套件: GF081至GF321(15件), 配A267滑轨及套筒夹

浅套筒

mm	6	12	A	B	C	D	E
5.5	FSM5.51	-	9.1	17.2	10.1	23.0	5.6
6	FSM61	FM6	9.1	17.2	11.1	23.0	5.6
7	FSM71	FM7	10.4	17.2	11.1	23.0	5.6
8	FSM81	FM8	11.6	17.2	11.1	23.0	6.4
9	FSM91	FM9	13.1	17.2	11.0	23.0	7.1
10	FSM101	FM10	14.3	17.2	11.0	23.0	7.1
11	FSM111	FM11	15.4	17.2	11.0	23.0	7.1
12	FSM121	FM12	16.5	17.2	11.9	23.8	8.1
13	FSM131	FM13	18.0	17.2	12.6	24.6	8.1
14	FSM141	FM14	19.6	18.6	13.2	26.2	9.1
15	FSM151	FM15	20.3	19.4	13.7	27.0	9.1
16	FSM161	FM16	21.1	20.2	15.0	27.8	10.4
17	FSM171	FM17	22.7	21.8	15.0	28.6	10.4
18	FSM181	FM18	24.3	23.2	15.7	28.6	10.9
19	FSM191	FM19	25.1	24.0	16.3	30.2	11.9
20	FSM201	FM20	26.3	25.3	16.6	40.0	12.4
21	FSM211	FM21	27.4	26.4	17.4	31.8	12.2
22	FSM221	FM22	28.3	27.2	17.4	32.5	13.2
23	FSM231	FM23	29.9	28.8	18.2	33.8	13.2
24	FSM241	FM24	31.5	30.5	19.0	35.0	14.4
25	FSM251	FM25	32.3	31.3	19.8	35.3	14.5
26	FSM261	FM26	33.8	32.9	20.6	37.0	14.3

公制镀铬6角套筒套件:

222FSMY - 公制6角浅套筒套件: FSM5.5至FSM261(22件), 配2个A269滑轨及套筒夹

212FSMY - 公制6角浅套筒套件: FSM5.5至FSM191(12件), 配A269滑轨及套筒夹

公制镀铬12角套筒套件:

219FMY - 公制12角浅套筒套件: FM6至FM26(FM24和FM25除外)(19件), 配2个A269滑轨及套筒夹

212FMY - 公制12角浅套筒套件: FM8至FM19(12件), 配A269滑轨及套筒夹

镀铬浅/深套筒套件:

224SFFSM - 公制6角浅/深套筒套件: FSM81至FSM191, 6角浅套筒加上SFSM8至SFSM19, 6角深套筒(24件), 配塑料盘



警告

- 请勿将机用套筒及其配件用于冲击工具
- 万向接头在使用中请勿触摸
- 请勿将镀铬或经工业处理的手动工具应用于动力工具
- 请勿使用损坏的工具
- 请正确使用工具
- 不正确的使用绝缘工具仍然会导致触电

FLANK DRIVE® 套筒 3/8" 方头

半深套筒

	6	12	A	B	C	D	E
1/4	FSS081	FDS081	13/32	11/16	1 1/8	1 5/8	7/32
5/16	FSS101	FDS101	15/32	11/16	1 1/8	1 5/8	9/32
3/8	FSS121	FDS121	9/16	11/16	1 1/8	1 5/8	5/16
7/16	FSS141	FDS141	5/8	11/16	1 1/8	1 5/8	3/8
1/2	FSS161	FDS161	23/32	11/16	1 1/2	1 5/8	13/32
9/16	FSS181	FDS181	25/32	23/32	1 1/2	1 5/8	13/32
5/8	FSS201	FDS201	27/32	51/64	1 1/2	1 5/8	13/32
11/16	FSS221	FDS221	15/16	7/8	1 1/2	1 5/8	7/16
3/4	FSS241	FDS241	1	15/16	1 1/2	1 5/8	15/32
13/16	FSS261	FDS261	1 1/16	1	1 1/2	1 5/8	1/2
7/8	FSS281	FDS281	1 5/32	1 3/32	1 1/2	1 5/8	17/32

211FSSY—6角半深套筒套件: FSS081至FSS281(FSS101除外)(11件), 配A269滑轨及套筒夹

211FDSY—12角半深套筒套件: FDS081至FDS281(FDS101除外)(11件), 配A269滑轨及套筒夹



半深套筒

mm	6	12	A	B	C	D	E
8	FSM8	FMS8	11.4	17.2	29.3	41.3	7.1
9	FSM9	FMS9	12.8	17.2	29.3	41.3	7.1
10	FSM10	FMS10	14.3	17.2	29.3	41.3	7.9
11	FSM11	FMS11	15.7	17.2	29.3	41.3	9.7
12	FSM12	FMS12	16.5	17.2	29.3	41.3	9.9
13	FSM13	FMS13	17.9	17.2	23.2	41.3	10.7
14	FSM14	FMS14	19.6	18.6	23.2	41.3	10.7
15	FSM15	FMS15	20.3	19.4	23.2	41.3	10.7
16	FSM16	FMS16	21.1	20.2	23.0	41.3	10.7
17	FSM17	FMS17	22.6	21.8	23.0	41.3	11.2
18	FSM18	FMS18	24.2	23.2	23.0	41.3	11.2
19	FSM19	FMS19	25.1	24.0	22.7	41.3	11.7

212FSMSY—公制6角半深套筒套件: FMS8至FMS19(12件), 配A269滑轨及套筒夹

212FMSY—公制12角半深套筒套件: FMS8至FMS19(12件), 配A269滑轨及套筒夹

深套筒

	6	12	6	12	A	B	C	D	E
1/4	SFS081	SF081	GSFS081	GSF081	15/32	11/16	1 11/16	2 1/8	1/4
5/16	SFS101	SF101	GSFS101	GSF101	15/32	11/16	1 11/16	2 1/8	7/32
11/32	SFS111	-	-	-	1/2	11/16	1 11/16	2 1/8	9/32
3/8	SFS121	SF121	GSFS121	GSF121	9/16	11/16	1 11/16	2 1/8	5/16
7/16	SFS141	SF141	GSFS141	GSF141	5/8	11/16	1 11/16	2 1/8	3/8
1/2	SFS161	SF161	GSFS161	GSF161	23/32	11/16	1 11/16	2 1/8	7/16
9/16	SFS181	SF181	GSFS181	GSF181	25/32	23/32	1 29/32	2 3/8	7/16
19/32	-	SF191	-	-	13/16	25/32	1 29/32	2 3/8	7/16
5/8	SFS201	SF201	GSFS201	GSF201	27/32	13/16	1 29/32	2 3/8	15/32
11/16	SFS221	SF221	GSFS221	GSF221	15/16	7/8	2 3/16	2 5/8	1/2
3/4	SFS241	SF241	GSFS241	GSF241	1	1	2 3/16	2 5/8	5/8
13/16	SFS261	SF261	GSFS261	GSF261	1 1/16	1	2 1/4	2 3/4	5/8
7/8	SFS281	SF281	GSFS281	GSF281	1 5/32	1 1/8	2 1/4	2 3/4	23/32
15/16	SFS301	SF301	GSFS301	GSF301	1 1/4	1 3/16	2 1/4	2 3/4	23/32
1	SFS321	SF321	GSFS321	GSF321	1 5/16	1 1/4	2 1/4	2 3/4	13/16

镀铬6角套筒套件:

214SFSY—6角深套筒套件: SFS081至SFS321(14件), 配A267滑轨及套筒夹

211SFSY—6角深套筒套件: SFS081至SFS281(SFS111除外)(11件), 配A269滑轨及套筒夹

镀铬12角套筒套件:

214SFY—12角深套筒套件: FS081至FS321(14件), 配A267滑轨及套筒夹

211SFY—12角深套筒套件: FS081至FS281(FS191除外)(11件), 配A269滑轨及套筒夹

工业处理6角套筒套件:

211GFSY—工业处理6角深套筒套件: GSFS081至GSFS281(11件), 配A269滑轨及套筒夹

工业处理12角套筒套件:

215GFY—工业处理12角深套筒套件: GSF081至GSF321(15件), 配A267滑轨及套筒夹



3/8" 方头 FLANK DRIVE® 套筒



212SFSMY

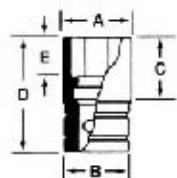

212SFSMY

深套筒

mm	6	12	A	B	C	D	E
6	SFSM6	SFM6	9.1	17.2	42.0	54.0	5.6
7	SFSM7	SFM7	10.5	17.2	42.0	54.0	5.6
8	SFSM8	SFM8	11.4	17.2	42.0	54.0	7.1
9	SFSM9	SFM9	12.8	17.2	42.0	54.0	7.1
10	SFSM10	SFM10	14.3	17.2	42.0	54.0	7.9
11	SFSM11	SFM11	15.7	17.2	42.0	54.0	9.7
12	SFSM12	SFM12	16.5	17.2	42.0	54.0	9.9
13	SFSM13	SFM13	18.0	17.2	42.0	54.0	10.7
14	SFSM14	SFM14	19.6	18.6	43.3	60.3	10.7
15	SFSM15	SFM15	20.3	19.4	43.3	60.3	10.7
16	SFSM16	SFM16	21.1	20.2	43.3	60.3	10.7
17	SFSM17	SFM17	22.7	21.8	43.6	66.7	11.2
18	SFSM18	SFM18	24.3	23.2	49.0	66.7	11.2
19	SFSM19	SFM19	25.1	24.0	49.0	66.7	15.5
20	SFSM20	-	26.3	25.3	48.1	66.7	12.2
21	SFSM21	-	27.5	26.4	47.6	66.7	12.4

镀铬6角套筒套件

211SFSMY—公制6角深套筒套件：SFSM6至SFSM26(21件)，配2个A269滑轨及套筒夹

212SFSMY—公制6角深套筒套件：SFSM8至SFSM19(12件)，配A269滑轨及套筒夹

镀铬12角套筒套件

214SFMY—公制12角深套筒套件：SFM6至SFM19(14件)，配A270滑轨及套筒夹

212SFMY—公制12角深套筒套件：SFM8至SFM19(12件)，配A269滑轨及套筒夹

FLANK DRIVE® 万向套筒

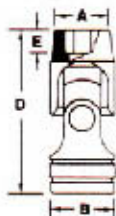

206FUA



206AFSA

浅套筒

mm	6	12	12	A	B	C	D
5/16	FS10B	FU10B	GFU10A	15/32	11/16	1 5/8	1/4
3/8	FS12B	FU12B	GFU12A	15/32	11/16	1 5/8	1/4
7/16	FS14B	FU14B	GFU14A	5/8	11/16	1 5/8	9/32
1/2	FS16B	FU16B	GFU16A	23/32	11/16	1 11/16	9/32
9/16	FS18B	FU18B	GFU18A	25/32	11/16	1 23/32	11/32
5/8	FS20B	FU20B	GFU20A	27/32	11/16	1 25/32	3/8
11/16	FS22B	FU22B	-	15/16	3/4	2	3/8
3/4	FS24B	FU24B	-	1	3/4	2 1/16	7/16
13/16	FS26B	FU26B	-	1 3/32	3/4	2 3/32	15/32
7/8	FS28B	FU28B	-	1 5/32	3/4	2 3/32	1/2
15/16	FS30B	FU30A	-	1 1/4	3/4	2 9/32	9/16
1	FS32B	FU32A	-	1 5/16	3/4	2 9/32	9/16

镀铬6角套筒套件

206AFSA—6角浅套筒套件：FS14B至FS24B(6件)，配塑料盘

镀铬12角套筒套件

212FUY—12角浅套筒套件：FU10B至FU32B(12件)，配A267滑轨及套筒夹

206FUA—12角浅套筒套件：FU14B至FU24B(6件)，配塑料盘



警告：

• 请勿将镀铬或经工业处理的手动工具应用于电动工具



FLANK DRIVE® 万向套筒 3/8" 方头

浅套筒

mm	6	12	A	B	D	E
7	FSUM7A	-	10.4	17.2	43.1	5.6
8	FSUM8A	-	11.9	17.2	43.1	6.4
10	FSUM10A	FUM10A	14.0	18.1	43.5	6.4
11	FSUM11A	-	15.3	18.1	43.5	7.1
12	FSUM12A	FUM12A	16.8	18.1	45.5	7.9
13	FSUM13A	FUM13A	18.1	18.1	45.5	7.9
14	FSUM14A	FUM14A	18.9	18.1	47.9	8.9
15	FSUM15A	FUM15A	20.5	18.1	47.9	8.9
16	FSUM16A	FUM16A	21.3	18.1	47.9	10.2
17	FSUM17A	FUM17A	22.9	18.9	50.7	10.4
18	FSUM18A	FUM18A	24.5	18.9	50.7	10.7
19	FSUM19A	FUM19A	25.3	18.9	52.5	11.7
21	FSUM21A	-	27.4	18.9	53.9	12.4
22	FSUM22A	-	28.4	18.9	53.9	13.0
24	FSUM24A	-	31.5	18.9	57.1	14.7



206FSUMA



镀铬六角套筒套件

215FSUMY—公制六角浅套筒套件：FSUM7A至FSUM24A(15件)，配A270滑轨及套筒夹

206FSUMA—公制六角浅套筒套件：FSUM10A至FSUM17A(FSUM11A和FSUM16A除外)(6件)，配塑料盘

镀铬12角套筒套件

209FUMY—公制12角浅套筒套件：FUM10A至FUM19A(9件)，配A269滑轨及套筒夹

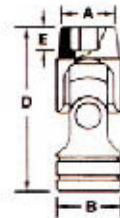

深套筒

mm	6	A	B	D	E
5/16	FSU10	15/32	11/16	2 13/32	9/32
3/8	FSU12	9/16	11/16	2 13/32	3/8
7/16	FSU14	5/8	11/16	2 13/32	7/16
1/2	FSU16	23/32	11/16	2 13/32	15/32
9/16	FSU18	25/32	11/16	2 13/32	17/32
5/8	FSU20	27/32	11/16	2 13/32	9/16
11/16	FSU22	15/16	3/4	2 15/32	9/16
3/4	FSU24	1	3/4	2 15/32	9/16

镀铬六角套筒套件

207FSU—6角深套筒套件：FSU12至FSU24(7件)，配塑料盘

207FSU



深套筒

mm	6	A	B	D	E
7	SFSUM7	10.8	17.2	63.6	6.1
8	SFSUM8	11.9	17.2	63.6	6.9
10	SFSUM10	14.4	18.1	63.6	7.4
11	SFSUM11	15.6	18.1	63.6	7.6
12	SFSUM12	17.1	18.1	63.6	8.1
13	SFSUM13	18.1	18.1	63.6	8.4
14	SFSUM14	18.9	18.1	63.6	9.1
15	SFSUM15	20.5	18.1	63.6	9.7
16	SFSUM16	21.3	18.1	63.6	10.4
17	SFSUM17	22.9	18.9	63.6	10.9
18	SFSUM18	24.5	18.9	63.6	10.9
19	SFSUM19	25.3	18.9	63.6	11.9
21	SFSUM21	28.3	18.9	63.6	12.4
22	SFSUM22	28.4	18.9	63.6	13.2
24	SFSUM24	31.6	18.9	63.6	14.7

镀铬六角套筒套件

215SFSUMY—公制六角深套筒套件：SFSUM7至SFSUM24(15件)，配A270滑轨及套筒夹

206SFSUM—公制六角深套筒套件：SFSUM10至SFSUM17(SFSUM11和SFSUM16除外)(6件)，配塑料盘



206SFSUM



3/8" 方头 专用套筒

FLANK DRIVE® 火花塞套筒

#		A	B	C	橡皮嵌块
标准手柄(镀铬)					
13/16"	S9704KA	7/8"	-	2 3/4"	S9705A2
5/8"	S9706KA	11/16"	-	2 27/32"	S9706KARI
3/4"	S9718KA	11/16"	-	2 13/32"	S9705A2
18mm	S9711KA	17.5mm	-	67.1mm	S9706KARI
加深套筒(镀铬)					
5/8"	S9720KA	-	-	5 31/32"	S9706KARI
13/16"	S9719KA	-	-	5 7/8"	S9705A2
可翻转延长杆(镀铬)					
5/8"	FSXK320A	-	2 15/32"	5 11/32"	S9706KARI
5/8"	FSXK620A	-	5 15/32"	8 11/32"	S9706KARI
5/8"	FSXK1220A	-	11 15/32"	14 11/32"	S9706KARI
5/8"	FSXK2420A	-	23 15/32"	26 11/32"	S9706KARI
13/16"	FSXK326A	-	2 7/16"	5 3/16"	S9705A2
13/16"	FSXK626A	-	5 7/16"	8 3/16"	S9705A2
13/16"	FSXK1226A	-	11 7/16"	14 3/16"	S9705A2
13/16"	FSXK2426A	-	23 7/16"	26 3/16"	S9705A2
18mm	FSXMK418A	87.4mm	-	159.8mm	S9705A2
磁性套筒(镀铬)					
5/8"	S9706KMAG	11/16"	-	2 19/32"	MSA3
13/16"	S9704KMAG	11/16"	-	2 11/16"	MSA2
万向套筒(镀铬)					
5/8"	S9706KFUA	-	-	3 23/32"	S9706KARI
13/16"	S9704KFUA	-	-	3 9/16"	S9705A2
双活动万向套筒(工业处理)					
5/8"	S9721A*	-	-	4 13/16"	S9706KARI
13/16"	S9726A*	-	-	4 13/16"	S9705A2
万向接头(工业处理)					
5/8"	S9710KB	-	-	3 25/32"	S9706KARI
13/16"	S9709KB	-	-	3 25/32"	S9705A2

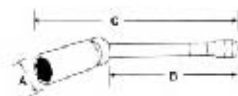

磁性塞套筒嵌块

A		B	适用套筒
0.540"	MSA1	5/8"	FSXK320A, FSXK620A, FSXK2420A
0.58"	MSA2	5/8", 13/16", 3/4", 18mm	S9706KA, S9706KFUA, S9709KB, S9710KB
0.700"	MSA3	13/16"	S9711KA, S9718KA, S9721A, S9726A
0.785"	MSA4	-	FSXK626A, FSXK2426A, S704KA, S704KFUA
			S9704KMAG, S9706KMAG

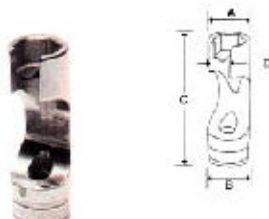

FLANK DRIVE® 开口螺帽套筒

#		A	B	C	D
3/8	FRX121	5/8	3/4	2 3/32	17/64
7/16	FRX141	23/32	3/4	2 3/32	21/64
1/2	FRX161	13/16	3/4	2 1/8	3/8
9/16	FRX181	7/8	13/16	2 15/32	25/64
5/8	FRX201	15/16	7/8	2 27/32	29/64
11/16	FRX221	1	15/16	3 7/32	1/2
3/4	FRX241	1 1/16	1	3 11/32	9/16

207FRXY—6角开口螺帽套筒套件: FRX121至FRX241(7件), 配A265滑轨及套筒夹

FLANK DRIVE® 开口螺帽套筒

mm		A	B	C	D
8	FRXM8	13.9	18.3	53.3	6.4
10	FRXM10	16.9	18.3	53.3	7.2
11	FRXM11	18.1	18.7	53.3	8.3
12	FRXM12	19.3	18.3	53.3	8.8
13	FRXM13	20.4	19.1	62.5	9.4
14	FRXM14	22.0	20.5	62.5	10.4
15	FRXM15	22.6	21.0	71.6	11.2
16	FRXM16	23.5	21.9	71.6	11.7
17	FRXM17	25.1	23.5	78.0	12.7
18	FRXM18	25.9	24.3	83.8	13.5
19	FRXM19	26.7	25.1	89.9	14.2

207FRXY—6角开口螺帽套筒套件: FRXM10至FRXM19(FRXM11, FRXM13和FRXM15除外)(7件), 配A265滑轨及套筒夹



警告:

- 请勿将镀铬或经工业处理的手动工具应用于动力工具
- 使用开口螺帽套筒时请和缓施力



专用套筒 3/8" 方头



TORX® 浅套筒

#		A	B	C
E8	FLE80A	15/32	11/16	1 5/32
E10	FLE100A	1/2	11/16	1 5/32
E11	FLE110A	9/16	11/16	1 5/32
E12	FLE120A	9/16	11/16	1 5/32
E14	FLE140A	5/8	11/16	1 5/32
E16	FLE160A	3/4	11/16	1 1/4
E18	FLE180A	13/16	25/32	1 5/16

213AFLEY—TORX® 浅套筒：1/4" 方头TLE40A至TLE100A、3/8" 方头FLE110A至FLE140A、及1/2" 方头SLE160至SLE240(13件)(E4至E24)，配滑轨及套筒夹

213AFLEY—TORX® 浅套筒：1/4" 方头TLE40A至TLE80A、3/8" 方头FLE100A至FLE180A(10件)，配A265滑轨及套筒夹

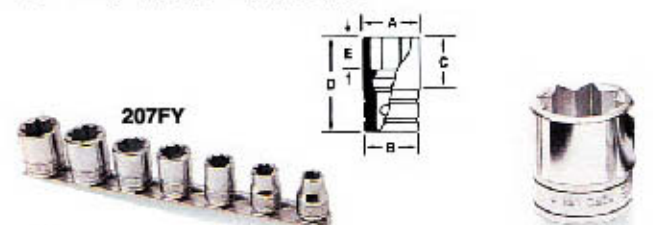

8角套筒

#		A	B	C	D	E
1/4	F308	1/2	21/32	3/8	27/32	7/32
5/16	F310	9/16	21/32	3/8	27/32	1/4
3/8	F312	21/32	11/16	15/32	15/16	9/32
7/16	F314	25/32	11/16	17/32	1	5/16
1/2	F316	7/8	25/32	17/32	1	5/16
9/16	F318	1	29/32	19/32	1 1/8	7/16
5/8	F320	1 1/16	31/32	19/32	1 1/8	7/16

207FY—8角套筒套件：F308至F320(7件)，配A265滑轨及套筒夹

扁头套筒

	A	B	C
GF22	11/16	7/64	1 1/4



旋转球延长杆套筒

mm		A	B	C	D
13	FLXM13	17.3	17.2	320.3	5.6
10	FLXM810	14.2	17.3	208	5.6
11	FLXM811	15.0	17.3	208	5.6
12	FLXM812	16.3	17.3	208	5.6
13	FLXM813	17.3	17.3	208	5.6

FLXM804—公制旋转球延长杆套筒套件：FLXM810至FLXM813(4件)，配塑料袋



TORX® 万向套筒

#		A	B	C	D
E8	FSE80	3/8	11/16	9/32	1 5/8
E10	FSE100	15/32	11/16	5/16	1 11/16
E12	FSE120	9/16	11/16	11/32	1 25/32
E14	FSE140	5/8	11/16	13/32	1 7/8
E16	FSE160	23/32	3/4	15/32	2 1/16



WEATHERHEAD® 半开套筒

#		A	B
3/8	FD120	11/16	1 1/4
7/16	FD140	13/16	1 1/4
15/32	FD150	7/8	1 1/4
1/2	FD160	15/16	1 1/4
17/32	FD170	1	1 1/4
9/16	FD180	1 1/16	1 1/4
19/32	FD190	1 1/16	1 1/4
21/32	FD210	1 3/16	1 3/8
11/16	FD220	1 3/16	1 3/8
3/4	FD240	1 1/4	1 3/8
25/32	FD250	1 1/4	1 3/8

211FDY—半开套筒套件：FD120至FD250(11件)，配A267滑轨及套筒夹

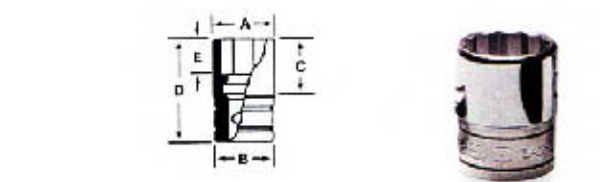

英制浅套筒

#		A	B	C	D	E	
.248	4BA	WF94	13/32	21/32	7/16	29/32	7/32
.281	3BA	WF95	7/16	21/32	7/16	29/32	9/32
.324	2BA	WF96	15/32	21/32	7/16	29/32	9/32
.338	3/16	WF96A	9/16	21/32	7/16	29/32	9/32
.365	1BA	WF97	9/16	11/16	7/16	29/32	9/32
.413	0BA	WF98	5/8	21/32	7/16	29/32	9/32
.443	1/4	WF99	5/8	11/16	7/16	29/32	9/32
.525	5/16	WF100	3/4	11/16	15/32	15/16	11/32
.600	3/8	WF101	13/16	3/4	17/32	1	3/8
.710	7/16	WF102	31/32	29/32	19/32	1 1/16	13/32
.820	1/2	WF103	1 3/32	1 3/32	11/16	1 5/32	15/32
.920	9/16	WF104	1 1/4	1 3/16	11/16	1 5/32	15/32

非FLANK DRIVE® 技术

3/8" 方头 专用套筒

FLANK DRIVE® 标准尺寸5角套筒



	A	B	C
B2190	1 1/8	1/2	1 1/16

用于5角螺钉, 防损防腐材料制成, 使用于石化、电力及水工业厂, 可保护门栓。

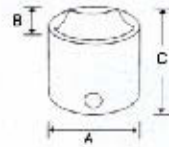

管道塞套筒

Hex Size	Part No.	A	Part No.	A
3/16	PPM406A	1 1/8	PP408A	1
1/4	PPM408A	1 1/8	PP409A	1
9/32	PPM409A	1 1/8	PP410A	1
5/16	PPM410A	1 1/8	PP411A	1
11/32	PPM411A	1 1/8	PP412A	1
3/8	PPM412A	1 1/8		

211PPMY—外/内管道塞套筒套件: PPM406A至PPM412A外部套筒, 及PP408A至PP412A内部套筒(11件), 配A267滑轨及套筒夹

管道塞套筒

Hex Size (mm)	Part No.	A	B	Part No.	A	B
6	PMM406A	16.4	31.0	PMP406A	17.2	25.8
8	PMM408A	17.2	31.0	PMP408A	17.2	28.6
10	PMM410A	17.2	28.4	PMP410A	18.8	25.4

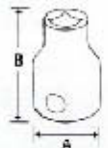
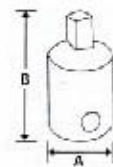

对使用者而言, 没有触电可能, 但小孔、裂缝或磨损处不绝缘。强度可与铜媲美。每件工具都经过单独的测试, 确保可防1000伏交流电压及1500伏直流电压。在UL记录中, 只有Snap-on®的绝缘工具经过检查与审计后确认完全符合IEC60900, Snap-on®承诺对产品的材料及工艺终生保用。美国专利号: 5,970,826 和6,126,882。



复合材料(绝缘)套筒

Hex Size	Part No.	A	B
3/8	CFDS12B	1	1 3/4
7/16	CFDS14B	1	1 3/4
1/2	CFDS16B	1 3/16	2
9/16	CFDS18B	1 3/16	2
5/8	CFDS20B	1 3/16	2
11/16	CFDS22B	1 3/8	2 1/4
3/4	CFDS24B	1 3/8	2 1/4

IHT208K—绝缘棘轮扳手/套筒套件: CFDS12B至CFDS24B套筒, 及CFS949A棘轮扳手, 配CO800塑料袋

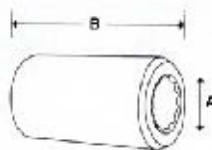

复合材料(绝缘)套筒

Hex Size (mm)	Part No.	A	B
10	CFDSM10A	25.1	44.9
12	CFDSM12A	29.6	51.2
13	CFDSM13A	29.6	51.2
14	CFDSM14A	29.6	51.2
15	CFDSM15A	29.6	51.2
16	CFDSM16A	33.5	57.4
17	CFDSM17A	33.5	57.4
18	CFDSM18A	33.5	57.4
19	CFDSM19A	33.5	57.4



IHT208K

警告:



- 请勿将镀铬或经工业处理的手动工具应用于动力工具
- 尽可能切断电源工作
- 请勿使用损坏的工具
- 请正确使用工具
- 不正常的的使用、打击、或折断工具会对人身造成伤害

FLANK DRIVE® 扭力转接头

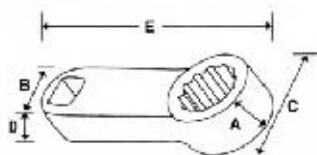

标准扭力转接头

11	12	12	A	B	C	D	E
1/4	-	GFRDH081	.475	29/32	7/16	.750	2
5/16	FRDH101	GFRDH101	.475	7/16	1/4	.750	2
3/8	FRDH121	GFRDH121	.570	7/16	5/16	.750	2
7/16	FRDH141	GFRDH141	.655	7/16	11/32	.750	2
1/2	FRDH161	GFRDH161	.740	7/16	11/32	.750	2
9/16	FRDH181	GFRDH181	.825	7/16	3/8	.750	2

航空标准: AS954E

205FRDH—镀铬套件: FRDH101至FRDH181(5件)

206GFRDH—工业处理套件: GFRDH081至GFRDH181(6件)

标准扭力转接头

mm	12	A	B	C	D	E
10	FRDHM10	7.8	11.1	17.1	18.8	50.8
13	FRDHM13	7.8	11.1	21.0	18.8	50.8
15	FRDHM15	7.8	11.1	25.1	18.8	50.8
18	FRDHM18	13.3	11.1	22.4	18.8	50.8

套筒螺丝刀头

208EFAY



内六角套筒螺丝刀头



标准套筒螺丝刀头

1/8	FA4E	GFA4E	2 1/16	-	1/4"	TMA4E2
9/64	FA4.5E	GFA4.5E	2 1/16	#8	-	TMA4.5E2
5/32	FA5E	GFA5E	2 1/16	#10	5/16"	TMA5E2
3/16	FA6E	GFA6E	2 1/16	1/4"	3/8"	TMA6E2
7/32	FA7E	GFA7E	2 1/16	-	7/16"	TMA7E2
1/4	FA8E	GFA8E	2 1/16	5/16"	1/2"	TMA8E2
5/16	FA10E	GFA10E	2 1/16	3/8"	5/8"	TMA10E2
3/8	FA12E	GFA12E	2 3/32	7/16" and 1/2"	3/4"	TMA12E2

长套筒螺丝刀头

3/16	FAL6E	-	3 1/8	1/4"	3/8"	FAL6E2
1/4	FAL8E	-	3 1/8	5/16"	1/2"	FAL8E2

加长套筒螺丝刀头

5/32	FASLE	-	6 1/16	#10	5/16"	FASLE2
3/16	FA6LE	-	6 1/8	1/4"	3/8"	FA6LE2
7/32	FA7LE	-	6 1/8	-	7/16"	FA7LE2
1/4	FA8LE	-	6 1/8	5/16"	1/2"	FA8LE2
5/16	FA10LE	-	6 1/16	3/8"	5/8"	FA10LE2
3/8	FA12LE	-	6 1/16	1/4"	3/4"	FA12LE2

短粗套筒螺丝刀头

7/32	FAXS7E	-	1 5/16	-	7/16"	FAXS7LE2
1/4	FAXS8E	-	1 11/32	5/16"	1/2"	FAXS8LE2
5/16	FAXS10E	-	1 13/32	3/8"	5/8"	FAXS10LE2
3/8	FAXS12E	-	1 15/32	1/4"	3/4"	FAXS12LE2

3/8" 方头镀铬套件:

208EFAY—标准长度套件: FA4E至FA12E(8件), 配A265滑轨及套筒夹

206EFAL—超长套件: FASLE至FA12LE(6件)

3/8" 方头工业处理套件:

208EGFAY—标准长度套件: GFA4E至GFA12E(8件), 配A265滑轨及套筒夹

组合1/4" 方头和3/8" 方头镀铬套件:

212EFTAY—标准长度套件: 1/4" 方头TMA2E至TMA3.5E六角套筒螺丝刀头, 及3/8" 方头FA4E至FA12E六角套筒螺丝刀头(12件), 配A269滑轨及套筒夹

208EFTAXSY—短粗套件: 1/4" 方头TMAXS4E至TMAXS6E短粗六角套筒螺丝刀头, 及3/8" 方头FAXS7E至FAXS12E短粗六角套筒螺丝刀头(8件), 配A269滑轨及套筒夹



212EFTAY



208EFTAXSY

标准内六角套筒螺丝刀头

长内六角套筒螺丝刀头

短粗内六角套筒螺丝刀头

加长内六角套筒螺丝刀头

3/8" 方头 套筒螺丝刀头

球头6角套筒螺丝刀头

		A	B
标准套筒螺丝刀头			
7/32	FAB7E	2 1/16	FAB7E2
1/4	FAB8E	2 1/16	FAB8E2
5/16	FAB10E	2 3/32	FAB10E2
3/8	FAB12E	2 3/32	FAB12E2
长套筒螺丝刀头			
5/32	FABL5E	5 1/16	FABL5E2
3/16	FABL6E	5 1/16	FABL6E2
7/32	FABL7E	5 1/16	FABL7E2
1/4	FABL8E	5 1/16	FABL8E2
5/16	FAB10E	5 1/16	FAB10E2
3/8	FAB12E	5 1/16	FAB12E2

组合1/4" 方头与3/8" 方头套件:

208EFTABY—标准套筒方头套件: 1/4" 方头TMAB4E至TMAB6E球头6角套筒螺丝刀头, 及3/8" 方头FAB7E至FAB12E球头6角套筒螺丝刀头(8件), 配A269滑轨及套筒夹

3/8" 方头套件:

206EFABL—长套筒方头套件: FABL5E至FABL12E(6件)

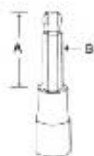

标准套筒螺丝刀头



208EFTABY



长套筒螺丝刀头



206EFABY

一字套筒螺丝刀头

		A	B
标准套筒螺丝刀头			
1/4 1/32	F23E	3	F23E2
5/16 3/64	F25E	3	F25E2A
3/8 1/16	F31E	3 7/16	F31E2
短套筒螺丝刀头			
1/4 1/32	F42E	1 13/16	F42E2
5/16 3/64	F52E	1 13/16	F52E2
3/8 1/16	F62E	1 27/32	F62E2



十字套筒螺丝刀头

		A	B
标准套筒螺丝刀头			
#2	FP22E	2 1/16	FP22E2
#3	FP32E	2 5/16	FP32E2
#4	FP41E	1 21/32	FP41E2-5
长套筒螺丝刀头			
#2	FP24E	4 1/32	FP24E2
#3	FP34E	4 1/32	FP34E2
#4	FP42E	2 9/16	FP42E2

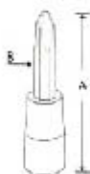

POZIDRIV® 标准套筒螺丝刀头

		A	B
#2	FPD22E	2 1/16	FPD22E2
#3	FPD32E	2	FPD32E2
#4	FPD41E	1 11/16	FPD41E2

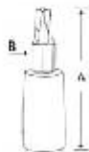

12角套筒螺丝刀头

		A	B	C	D
标准套筒螺丝刀头					
6	FTSM6E	17.2	21.6	48.5	FTSM6E2-2
8	FTSM8E	17.2	31.1	58.0	FTSM8E2
10	FTSM8E	18.0	40.9	67.8	FTSM8E2
长套筒螺丝刀头					
8	FTSM8LE	17.2	57.7	84.6	FTSM8LE2

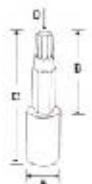

领结型套筒螺丝刀头

		A	B
3/8	F29A	3/8	1 3/4
5/16	F30	19/64	1 3/4



警告:



• 请勿将镀铬或经工业处理的手动工具应用于动力工具

套筒螺丝刀头 3/8" 方头

内六角套筒螺丝刀头

标准套筒螺丝刀头		A	B	C	D
4	FAM4E	17.2	25.4	52.3	FAM4E2
5	FAM5E	17.2	25.7	52.6	FAM5E2
6	FAM6E	17.2	25.7	52.6	FAM6E2
7	FAM7E	17.2	25.7	52.6	FAM7E2
8	FAM8E	17.2	25.1	52.1	FAM8E2
9	FAM9E	18.0	25.7	52.6	FAM9E2
10	FAM10E	18.0	25.5	52.5	FAM10E2-5
11	FAM11E	20.4	38.9	69.9	FAM11E2
12	FAM12E	21.2	38.9	69.9	FAM12E2
13	FAM13E	22.8	38.9	69.9	FAM13E2
14	FAM14E	24.4	38.9	69.9	FAM14E2
加长套筒螺丝刀头					
4	FAML4E	17.2	127	153.9	FAML4E2
5	FAML5E	17.2	127	153.9	FAML5E2
6	FAML6E	17.2	127	153.9	FAML6E2
7	FAML7E	17.2	127	153.9	FAML7E2
8	FAML8E	17.2	127	153.9	FAML8E2
10	FAML10E	18.0	126.5	153.4	FAML10E2
短粗套筒螺丝刀头					
7	FAMXS7E	17.2	7.8	34.7	FAMXS7E2
8	FAMXS8E	17.2	8.8	35.7	FAMXS8E2
10	FAMXS10E	18.0	10.7	37.7	FAMXS10E2
万向短粗套筒螺丝刀头					
10	FUAM10E	59.7	-	10.3	FUAM10E3

3/8" 方头公制套件:

211EFAMY - 公制标准套件: FAM4E至FAM14E(11件), 配A269滑轨及套筒夹
 207EFAMY - 公制标准套件: FAM4E至FAM10E(7件), 配A265滑轨及套筒夹
 206EFAMY - 公制加长套件: FAML4E至FAML10E(6件), 配A265滑轨及套筒夹
组合1/4" 方头与3/8" 方头套件:
 210EFTAMY - 公制标准套件: 1/4" 方头TMAM2E至TMAM3E标准长度六角套筒方头, 及3/8" 方头FAM4E至FAM10E标准长度六角套筒螺丝刀头(10件), 配A269滑轨及套筒夹
 208AFTAMXY - 公制短粗套件: 1/4" 方头TMAMXS3E至TMAMXS6E短粗六角套筒方头, 及3/8" 方头FAMXS7E至FAMXS12E短粗六角套筒螺丝刀头(8件), 配A265滑轨及套筒夹



标准12角套筒螺丝刀头

mm	A	B	C	D	
8	FADM8E	18	24.4	51.3	FADM8E2

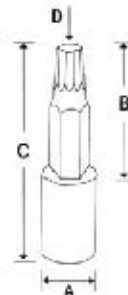

球头六角套筒螺丝刀头

标准套筒螺丝刀头		A	B	C	D
7	FABM7E	17.2	25.6	52.5	FABM7E2-2
8	FABM8E	17.2	25.6	52.5	FABM8E2
9	FABM9E	18.0	25.6	52.5	FABM9E2
10	FABM10E	18.0	25.6	52.5	FABM10E2
长套筒螺丝刀头					
4	FABLM4E	17.2	101.6	129.3	FABLM4E2
5	FABLM5E	17.2	101.6	128.5	FABLM5E2
6	FABLM6E	17.2	101.6	128.5	FABLM6E2
8	FABLM8E	17.2	100.3	127.3	FABLM8E2
10	FABLM10E	18.0	101.3	128.3	FABLM10E2

组合1/4" 方头和3/8" 方头套件:

208EFTABMY - 公制标准套件: 包括1/4" 方头TMABM3E至TMABM6E标准套筒螺丝刀头, 及3/8" 方头FABM7E至FABM10E标准长度套筒螺丝刀头(8件), 配A265滑轨及套筒夹

3/8" 方头公制套件:

205EFABLM - 公制长套件: FABLM4E至FABLM10E(5件)



标准套筒螺丝刀头 短粗套筒螺丝刀头 加长套筒螺丝刀头

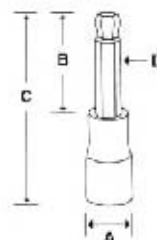

标准套筒螺丝刀头 长套筒螺丝刀头



3/8" 方头 套筒螺丝刀头

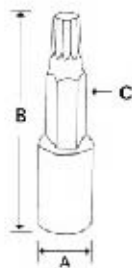

TORX® 套筒螺丝刀头

防损型TORX® 套筒方头中心有孔，强度高，防磨损。

#	A			B	C
标准套筒螺丝刀头					
T27	.195	FTX27E	GFTX27E	1 3/4	FTX27E2
T30	.216	FTX30E	GFTX30E	1 3/4	FTX30E2
T40	.260	FTX40E	GFTX40E	1 3/4	FTX40E2
T45	.306	FTX45E	GFTX45E	2 1/16	FTX45E2
T50	.346	FTX50E	GFTX50E	2 1/16	FTX50E2
T55	.440	FTX55E	GFTX55E	2 1/32	FTX55E2
T60	.520	FTX60E	-	2 5/16	FTX60E2
长套筒螺丝刀头					
T27	.195	FTXL27E	-	4 1/4	FTXL27E2
T30	.216	FTXL30E	-	4 1/4	FTXL30E2
T40	.260	FTXL40E	-	4 1/4	FTXL40E2
T45	.306	FTXL45E	-	4 1/4	FTXL45E2
T50	.346	FTXL50E	-	2 7/8	FTXL50E2
重型套筒螺丝刀头					
T27	.195	FTXB27E	-	1 13/16	FTXB27E2
T30	.216	FTXB30E	-	1 13/16	FTXB30E2
T40	.260	FTXB40E	-	1 13/16	FTXB40E2
T45	.306	FTXB45E	-	2 1/16	FTXB45E2-5
T50	.346	FTXB50E	-	2 1/16	FTXB50E2
T55	.440	FTXB55E	-	2 1/64	FTXB55E2
抗损套筒螺丝刀头					
T27	.195	FTXR27E	-	1 3/4	FTXR27E2
T30	.216	FTXR30E	-	1 3/4	FTXR30E2
T40	.260	FTXR40E	-	1 3/4	FTXR40E2
T45	.306	FTXR45E	-	2 1/8	FTXR45E2
T50	.346	FTXR50E	-	2 1/8	FTXR50E2



标准套筒螺丝刀头



重型套筒可移动螺丝刀头



抗损套筒螺丝刀头



长套筒螺丝刀头

镀铬TORX® 套筒螺丝刀头套件：

207EFTXY - 标准长度TORX® 套件：FTX27E至FTX55E，FTX47E套筒螺丝刀头(7件)，配A265滑轨及套筒夹

工业处理TORX® 套筒螺丝刀头套件：

207EGFTX - 标准长度TORX® 套筒螺丝刀头套件；GFTX27E至GFTX55E，及GFTX500E套筒螺丝刀头(7件)

组合1/4" 方头与3/8" 方头镀铬TORX® 套筒螺丝刀头套件：

212EFTXY - 1/4" 方头与3/8" 方头TORX® 套筒螺丝刀头套件：包括1/4" 方头TTX8E至TTX25ETORX套筒螺丝刀头，及3/8" 方头FTX27E至FTX55E及FTX47ETORX套筒螺丝刀头(12件)，配A269滑轨及套筒夹

209EFTXBY - 重型可移动TORX® 套筒螺丝刀头套件：包括1/4" 方头TTXB15E至TTXB25E TORX® 套筒螺丝刀头，加上3/8" 方头FTXB27E至FTXB55ETORX

套筒螺丝刀头(9件)，配A259滑轨及套筒夹

组合1/4" 方头和3/8" 方头工业处理套件：

TORX® 套筒螺丝刀头套件：

212EGFTXY - 标准长度TORX® 套筒螺丝刀头套件：包括1/4" 方头GTTX8E至GTTX25ETORX套筒螺丝刀头，及3/8" 方头GFTX27E至GFTX55E及GFTX47ETORX套筒螺丝刀头(12件)，配A269滑轨及套筒夹

组合1/4" 方头和3/8" 方头抗损套件：

210EFTXRY - 抗损组合方头TORX® 套筒螺丝刀头套件：1/4" 方头TTXR8E至TTXR25ETORX套筒螺丝刀头，及3/8" 方头FTXR27E至FTXR50ETORX套筒螺丝刀头(10件)，配A265滑轨及套筒夹

专用TORX® 套筒螺丝刀头

#	A			B	C	
T40	.260	FTXEL40E	-	加长	7 1/2	FTXEL40E2
T45	.350	FTXEL45E	-	加长	7 11/16	FTXEL45E2
T47	.310	FTX47E	-	-	2 1/16	FTX47E2
T47	.310	-	GFTX500E	-	2 1/16	FTX500E2



警告：

• 请勿将镀铬或经工业处理的手动工具应用于动力工具

FLANK DRIVE® 机用套筒 3/8" 方头

浅套筒

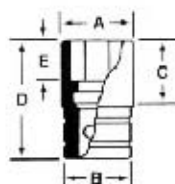

FLANK DRIVE® 机用浅套筒

11	6	12	A	B	C	D	E
5/16	PF100A	-	1/2	11/16	7/16	7/8	3/16
11/32	PF110A	-	17/32	11/16	7/16	7/8	3/16
3/8	PF120A	PFDH120A	9/16	11/16	7/16	7/8	3/16
7/16	PF140A	PFDH140A	21/32	3/4	7/16	15/16	9/32
1/2	PF160	-	3/4	3/4	7/16	15/16	9/32
9/16	PF180	-	13/16	13/16	7/16	31/32	11/32
11/16	PF220	-	31/32	31/32	9/16	1 1/32	3/8
3/4	PF240	-	1 1/16	1 1/16	9/16	1 1/32	13/32

FLANK DRIVE® 机用浅套筒

mm	6	A	B	C	D	E
8	PFM8A	12.8	17.2	11.1	23.0	6.4
10	PFM10A	14.4	17.2	11.1	23.0	7.1
11	PFM11A	15.6	17.2	11.1	23.0	7.1
12	PFM12A	17.0	17.2	11.9	23.8	8.1
13	PFM13	18.0	18.0	11.6	24.6	8.1
15	PFM15	20.3	20.3	13.7	26.2	9.1
18	PFM18	24.3	24.3	15.7	28.6	10.9
19	PFM19	25.1	25.1	17.1	30.1	11.9

深套筒



FLANK DRIVE® 机用深套筒

11	6	A	B	C	D	E
3/8	SPF120A	9/16	11/16	1 1/16	2 1/8	9/32
7/16	SPF140A	21/32	3/4	1 1/16	2 1/8	11/32
1/2	SPF160	3/4	3/4	1 1/16	2 1/8	3/8
9/16	SPF180	13/16	13/16	1 1/16	2 1/8	7/16

ASME/ANSI: B17.2-1995

FLANK DRIVE® 机用深套筒

mm	6	A	B	C	D	E
8	SPFM8A	12.8	17.2	33.0	54.0	5.6
10	SPFM10A	14.4	17.2	38.1	53.8	5.6
11	SPFM11A	15.6	17.2	38.1	53.8	6.4
12	SPFM12A	17.0	17.2	38.1	53.8	6.9
13	SPFM13	18.1	18.1	38.1	53.8	7.6
15	SPFM15	20.5	20.5	43.2	60.5	9.1
17	SPFM17	23.4	23.4	48.3	66.8	10.4
18	SPFM18	24.3	24.3	48.3	66.8	10.9
19	SPFM19	25.1	25.1	48.3	66.8	12.2

磁性套筒



FLANK DRIVE® 磁性浅套筒

11	6	A	B	D	E
5/16	MFIM101	15/32	11/16	1 1/16	3/32
3/8	MFIM121	17/32	11/16	1 1/16	1/8
7/16	MFIM141	5/8	11/16	1 1/16	5/32
1/2	MFIM161	25/32	25/32	1 1/16	5/32
9/16	MFIM181	7/8	7/8	1 1/16	5/32

205MFIM—6角浅套筒套件: MFIM101至MFIM181(5件)

FLANK DRIVE® 磁性浅套筒

mm	6	A	B	D	E
8	MFIMM8	12.8	17.2	28.6	2.4
10	MFIMM10A	15.1	17.2	29.1	4.7
11	MFIMM11	16.7	18.9	28.6	3.5
12	MFIMM12	18.1	19.1	28.6	3.7
13	MFIMM13	19.4	19.4	28.6	3.9
15	MFIMM15	21.8	21.8	28.6	3.9

206MFIMM—公制6角浅套筒套件: MFIMM8至MFIMM15(6件)

磁性弹簧深套筒

mm	6	A	B	D	E
8	SMFIMM8A	12.8	17.2	50.8	7.1
12	SMFIMM12A	18.1	19.1	50.8	7.1
13	SMFIMM13A	19.4	19.4	50.8	7.6



3/8" 方头

FLANK DRIVE® 机用套筒

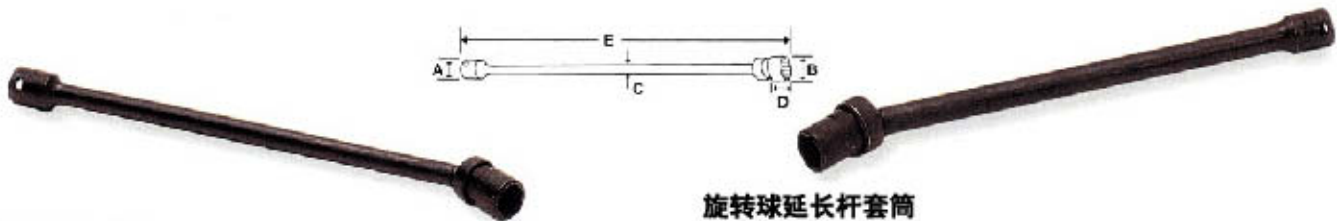

旋转球延长杆套筒

#	6	A	B	C	D	E
1/2	PFSX916	11/16	23/32	13/32	5/16	9 5/8

旋转球延长杆套筒

mm	6	A	B	C	D	E
10	PFSXM910	17.2	14.4	10.0	5.6	243.4
12	PFSXM912	17.2	17.0	10.0	6.8	244.6
13	PFSXM913	17.2	18.4	12.4	7.6	246.0
14	PFSXM914	17.2	19.8	12.4	9.1	248.0

表面驱动头套筒

工业领域中，表面驱动头套筒可用于组装流水线。特有的斜面设计可使套筒在动力螺母安装器上转动时与紧固件啮合。浅系列与深系列均获美国专利：4,512,220。

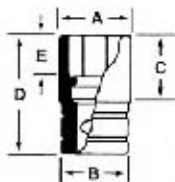

表面驱动头浅套筒

#	6	A	B	C	D	E
1/2	DF16	3/4	3/4	19/32	1 1/16	9/32
9/16	DF18	13/16	13/16	19/32	1 3/32	5/16

表面驱动头浅套筒

mm	6	A	B	C	D	E
10	DFM10	14.4	17.2	14.7	26.2	7.1
13	DFM13	19.7	19.7	15.1	27.0	7.4



表面驱动头深套筒

#	6	A	B	C	D	E
3/8	DFS12	9/16	11/16	1 11/16	2 1/8	9/32
7/16	DFS14	21/32	11/16	1 21/32	2 1/8	11/32
1/2	DFS16	3/4	3/4	1 7/16	2 1/8	3/8
9/16	DFS18	13/16	13/16	1 11/16	2 3/8	13/32



表面驱动头深套筒

mm	6	A	B	C	D	E
10	DFSM10	14.5	17.2	42.5	54.0	8.4
13	DFSM13	19.7	19.7	36.8	54.0	10.4
15	DFSM15	21.3	21.3	36.8	60.3	10.4

动力套筒螺丝刀头



内6角动力套筒螺丝刀头

#	C	D		
1/8	PFA4E	2 1/16	1/4	TMA4E2
9/64	PFA4.5E	2 1/16	#8	TMA4.5E2
5/32	PFA5E	2 1/16	#10	FA5E2
3/16	PFA6E	2 1/16	1/4"	FA6E2
7/32	PFA7E	2 1/16	-	FA7E2
1/4	PFA8E	2 1/16	7/16	FA8E2
5/16	PFA10E	2 1/16	3/8	FA10E2
3/8	PFA12E	2 1/16	1/4 & 1/2	FA12E2-5

208EPFAY - 内6角套件：PFA4E至PFA12E(8件)。配A265滑轨及套筒夹



内6角动力套筒螺丝刀头

mm	A	B	D	
4	PFAM4E	17.2	25.3	FAM4E2
5	PFAM5E	17.2	25.7	FAM5E2
6	PFAM6E	17.2	25.7	FAM6E2
7	PFAM7E	17.2	25.6	FAM7E2
8	PFAM8E	17.2	25.2	FAM8E2
9	PFAM9E	18.0	25.6	FAM9E2
10	PFAM10E	18.0	25.5	SAM10E2-5

207EPFAMY - 内6角套件：PFAM4E至PFA10E(7件)。配A265滑轨及套筒夹



警告：



- 请勿将镀铬或经工业处理的手动工具应用于动力工具
- 方向接头在使用中请勿触摸

机用套筒螺丝刀头

3/8" 方头

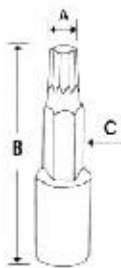

动力套筒螺丝刀头

#	A		B	C
T27	.195	PFTX27E	1 3/4	FTX27E2
T30	.216	PFTX30E	1 3/4	FTX30E2
T40	.260	PFTX40E	1 3/4	FTX40E2

210EPTXY-TORX® 套筒螺丝刀头套件：包括1/4" 方头PTTX15E至PTTX25E 套筒螺丝刀头、3/8" 方头PFT27E至PFTX40E套筒螺丝刀头，及1/2" 方头 PSTX45E、PSTX50E与PSTX500E套筒螺丝刀头(10件)，配A269滑轨及套筒夹

专用机用浅套筒

#	6	A	B	C	D	E
E7	PFLE070	3/8	11/16	17/32	1 1/32	1/4
E8	PFLE080	13/16	11/16	17/32	1 1/32	9/32



TORX® 紧固件专用机用套筒

机用套筒附件



锁定钮延长杆

	A	B
PF3	1/2	3
PF6	1/2	6
PF11A	1/2	11

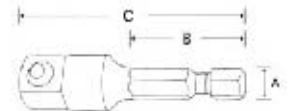
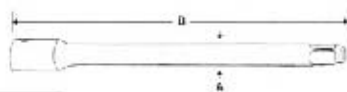

6角/4角转接头

	A	B	C
A3042	1/4	1	2

转接头

	A	B	C	D
PA4A	3/8	1/2	15/16	1 15/32
PA2A	1/2	3/8	3/4	1 5/16

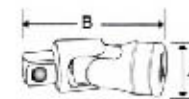
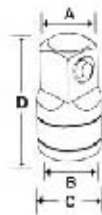

万向连接头

	A	B
PFU8A	3/4	1 31/32



FLANK DRIVE® 冲击套筒

冲击浅套筒

#	6	12	A	B	C	D	E
5/16	IMFL100	-	1/2	11/16	3/8	7/8	1/4
3/8	IMFL120	IMDFL120	9/16	11/16	7/16	7/8	3/16
7/16	IMFL140	IMDFL140	21/32	3/4	7/16	15/16	9/32
1/2	IMFL160	IMDFL160	3/4	3/4	7/16	15/16	9/32
9/16	IMFL180	IMDFL180	13/16	13/16	7/16	15/16	9/32
5/8	IMFL200	IMDFL200	29/32	29/32	7/16	15/16	9/32
11/16	IMFL220	IMDFL220	31/32	31/32	9/16	1 1/32	3/8
3/4	IMFL240	IMDFL240	1 1/16	1 1/16	9/16	1 3/32	13/32
13/16	IMFL260	-	1 1/8	1 1/8	11/16	1 3/16	1/2
7/8	IMFL280	-	1 3/16	1 3/16	3/4	1 9/32	1/2
15/16	IMFL300	-	1 9/32	1 9/32	13/16	1 5/16	17/32
1	IMFL320	-	1 11/32	1 9/32	13/16	1 5/16	9/16

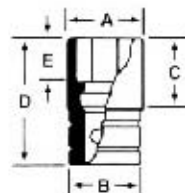

212IMFYL - 6角浅套筒套件：IMFL100至IMFL320(12件)，配A267滑轨及套筒夹
207IMDYLM - 12角浅套筒套件：IMDFL120至IMDFL240(7件)，配A265滑轨及套筒夹

3/8" 方头 FLANK DRIVE® 冲击套筒

冲击浅套筒 (圆括号内的数字仅适用于12角套筒)

mm	6	12	A	B	C	D	E
8	IMFML8	IMDFML8	12.8	17.2	11.1	23	6.4
9	IMFML9	-	14.0	17.2	11.0	23	7.1
10	IMFML10	IMDFML10	15.1	17.2	11.0	23	7.1
11	IMFML11	IMDFML11	16.7	18.8	11.6	23.8	7.1
12	IMFML12	IMDFML12	18.0	18.0	11.6	23.8	7.1
13	IMFML13	IMDFML13	18.8 (19.4)	18.8 (19.4)	12.4 (10.9)	24.6 (23.8)	7.4 (7.6)
14	IMFML14	IMDFML14	20.4	20.4	13.5	27.0	9.1
15	IMFML15	IMDFML15	21.2	21.2	13.5	27.0	9.1
16	IMFML16	IMDFML16	22.7	22.7	14.1	27.8	10.4
17	IMFML17	IMDFML17	24.3	24.3	14.4	28.2	10.2
18	IMFML18	IMDFML18	25.1	25.1	14.3	29.0	10.9
19	IMFML19	IMDFML19	26.7	26.7	15.6	26.7	11.7
20	-	IMDFML20	28.3	28.3	16.5	28.3	12.2
21	IMFML21	IMDFML21	28.8 (29.1)	28.8 (29.1)	17.5	28.8 (29.1)	12.2 (12.4)
22	IMFML22	IMDFML22	29.9	29.9	18.3	29.9	13
23	IMFML23	-	31.5	31.5	19.3	31.5	13.2
24	IMFML24	-	32.6	32.6	21.1	32.6	14.5



6角套筒套件:

217IMFMYLM—6角浅套筒套件: IMFML8至IMFML24(17件), 配A270滑轨及套筒夹

214IMFMYLM—6角浅套筒套件: IMFML8至IMFML19, 及IMFML21及IMFML24(14件), 配A267滑轨及套筒夹

12角套筒套件:

214IMDFMYLM—12角浅套筒套件: IMDFML8至IMDFML22(14件), 配A267滑轨及套筒夹

207IMDFMYLM—12角浅套筒套件: IMDFML10至IMDFML18(IMDFML11及IMDFML16除外)(7件), 配A265滑轨及套筒夹



半深套筒

mm	6	A	B	C	D	E
5/16	IMFSL10	1/2	11/16	1 5/32	1 5/8	1/4
3/8	IMFSL12	9/16	11/16	1 5/32	1 5/8	9/32
7/16	IMFSL14	21/32	3/4	1 5/32	1 5/8	11/32
1/2	IMFSL16	3/4	3/4	1 5/32	1 5/8	13/32
9/16	IMFSL18	13/16	13/16	1 5/32	1 5/8	13/32
5/8	IMFSL20	29/32	29/32	1 5/32	1 5/8	13/32
11/16	IMFSL22	31/32	31/32	1 5/32	1 5/8	7/16
3/4	IMFSL24	1 1/16	1 1/16	1 5/32	1 5/8	15/32
13/16	IMFSL26	1 1/8	1 1/8	1 5/32	1 5/8	1/2
7/8	IMFSL28	1 3/16	1 3/16	1 5/32	1 5/8	17/32

210IMFSYLM—6角半深套筒套件: IMFSL10至IMFSL28(10件), 配A267滑轨

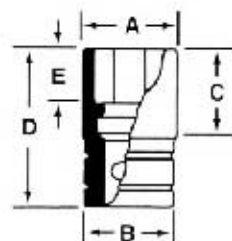

FLANK DRIVE® 冲击套筒 3/8" 方头

半深套筒

mm	6	A	B	C	D	E
8	IMFMSL8	12.8	17.2	29.3	41.3	6.4
9	IMFMSL9	14.0	17.2	29.3	41.3	7.1
10	IMFMSL10	15.1	17.2	29.3	41.3	9.7
11	IMFMSL11	17.2	17.2	29.3	41.3	9.7
12	IMFMSL12	18.0	18.0	29.3	41.3	9.7
13	IMFMSL13	19.6	19.6	29.3	41.3	10.4
14	IMFMSL14	20.4	20.4	29.3	41.3	10.4
15	IMFMSL15	21.2	21.2	29.3	41.3	10.4
16	IMFMSL16	22.7	22.7	29.3	41.3	10.4
17	IMFMSL17	24.3	24.3	29.3	41.3	11.2
18	IMFMSL18	25.1	25.1	29.3	41.3	11.2
19	IMFMSL19	26.7	26.7	29.3	41.3	11.7

212IMFMSYLM—公制6角半深套筒套件：IMFMSL8至IMFMSL19(12件)，配A267滑轨及套筒夹

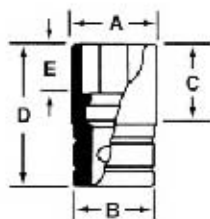

深套筒

mm	6	12	A	B	C	D	E
8	SIMFML8	SIMDFML8	12.8	17.2	38.1	54.0	6.4
9	SIMFML9	SIMDFML9	14.0	17.2	38.1	54.0	7.1
10	SIMFML10	SIMDFML10	15.1	17.2	38.1	54.0	9.7
11	SIMFML11	SIMDFML11	17.2	17.2	38.1	54.0	9.7
12	SIMFML12	SIMDFML12	18.0	18.0	38.1	54.0	9.7
13	SIMFML13	SIMDFML13	19.6	19.6	38.1	54.0	10.4
14	SIMFML14	SIMDFML14	20.4	20.4	42.7	60.3	10.4
15	SIMFML15	SIMDFML15	21.2	21.2	42.7	60.3	10.4
16	SIMFML16	SIMDFML16	22.7	22.7	42.7	60.3	10.4
17	SIMFML17	SIMDFML17	24.3	24.3	47.0	66.7	11.2
18	SIMFML18	SIMDFML18	25.1	25.1	47.0	66.7	11.2
19	SIMFML19	SIMDFML19	26.7	26.7	47.0	66.7	14.2
20	SIMFML20	-	28.3	28.3	47.0	66.7	12.2
21	SIMFML21	SIMDFML21	28.9	28.9	47.0	66.7	12.4
22	SIMFML22	-	29.9	29.9	51.6	73.0	13.0
23	SIMFML23	-	31.5	31.5	51.6	73.0	13.0
24	SIMFML24	SIMDFML24	33.0	33.0	58.2	73.0	14.7

217SIMFMYLM—公制6角深套筒套件：SIMFML8至SIMFML24(17件)，配A270滑轨及套筒夹

214SIMFMYLM—公制6角深套筒套件：SIMFML8至SIMFML19，及SIMFML21与SIMFML24(14件)，配A267滑轨及套筒夹

214SIMDFMYLM—公制12角深套筒套件：SIMDFML8至SIMDFML19，及SIMDFML21与SIMDFML24(14件)，配A267滑轨及套筒夹

深套筒

	6	A	B	C	D	E
5/16	SIMFL100	1/2	11/16	1 1/2	2 1/8	3/16
3/8	SIMFL120	9/16	11/16	1 1/2	2 1/8	9/32
7/16	SIMFL140	21/32	3/4	1 1/2	2 1/8	5/16
1/2	SIMFL160	3/4	3/4	1 1/2	2 1/8	3/8
9/16	SIMFL180	13/16	13/16	1 1/2	2 3/8	7/16
5/8	SIMFL200	29/32	29/32	1 1/2	2 3/8	7/16
11/16	SIMFL220	31/32	31/32	1 1/2	2 5/8	1/2
3/4	SIMFL240	1 1/16	1 1/16	1 1/2	2 5/8	9/16
13/16	SIMFL260	1 1/8	1 1/8	2 1/16	2 3/4	9/16
7/8	SIMFL280	1 3/16	1 3/16	2 1/16	2 3/4	9/16
15/16	SIMFL300	1 9/32	1 9/32	2 1/32	2 3/4	9/16
1	SIMFL320	1 11/32	1 11/32	2 3/16	2 3/4	5/8

212SIMFYLM—6角深套筒套件：SIMFL100至SIMFL320(12件)，配A267滑轨及套筒夹

207SIMFYLM—6角深套筒套件：SIMFL120至SIMFL240(7件)，配A265滑轨及套筒夹



3/8" 方头 FLANK DRIVE® 冲击套筒

TORX® 冲击套筒

#	6	A	B	C	D	E
E10	IMFLE100A	1/2	11/16	11/16	1 5/32	5/16
E12	IMFLE120A	19/32	11/16	11/16	1 5/32	11/32
E14	IMFLE140A	11/16	11/16	11/16	1 5/32	13/32
E16	IMFLE160A	3/4	3/4	13/16	1 1/4	7/32
E18	IMFLE180A	27/32	27/32	15/16	1 5/16	1/2

210IMFLEYA – TORX® 套筒套件: 1/4" 方头IMTLE40A至IMTLE80A套筒, 及3/8" 方头IMFLE100A至IMFLE180A套筒(10件), 配A265滑轨及套筒夹

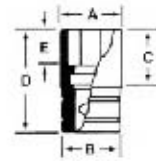

专用冲击套筒

只需将套筒放置于紧固件上, 使用3/8" 方头驱动把或冲击枪转动, 作用在紧固件上超强的扭力即可方便快捷的卸去已损坏或打圆的螺钉及螺帽, 而无需在紧固件上方敲击套筒, 可工作的紧固件最大直径达3/4" (19毫米), 应用于油盘排油塞, 喷口总管螺母, 柱头螺栓, 管头及被腐蚀的船用紧固件。

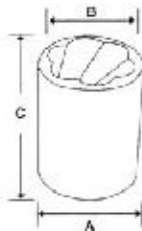

209TFSMYA



螺旋状浅套筒

mm	6	A	B	C
3/8	TFSY121A	11/16 17.5	9/16 14.3	1 1/4 31.8
7/16 (11)	TFSY141A	11/16 17.5	21/32 16.7	1 1/4 31.8
1/2	TFSY161A	3/4 19.1	3/4 19.1	1 1/4 31.8
9/16	TFSY181A	13/16 20.6	13/16 20.6	1 1/4 31.8
5/8 (16)	TFSY201A	29/32 23.0	29/32 23.0	1 1/4 31.8
11/16	TFSY221A	31/32 24.6	31/32 24.6	1 3/8 35.0
3/4 (19)	TFSY241A	1 1/16 27.0	1 1/16 27.0	1 3/8 35.0
10	TFSY10A	19/32 15.1	19/32 15.1	1 1/4 31.8
12	TFSY12A	11/16 17.5	11/16 17.5	1 1/4 31.8
13	TFSY13A	3/4 19.1	3/4 19.1	1 1/4 31.8
14	TFSY14A	13/16 20.6	13/16 20.6	1 1/4 31.8
15	TFSY15A	13/16 20.6	13/16 20.6	1 1/4 31.8
17	TFSY17A	31/32 24.6	31/32 24.6	1 3/8 35.0

213TFSYA – 英制/公制螺旋状浅套筒套件: 包括所有TFSY系列浅套筒(13件), 配塑料盘
209TFSMYA – 英制/公制螺旋状浅套筒套件: TFSY10A至TFSY17A, 及TFSY141A, TFSY201A与TFSY241A(9件), 配塑料盘

螺旋状深套筒

mm	6	A	B	C
3/8	TFSY121A	11/16 17.5	9/16 14.3	2 1/8 54.0
7/16 (11)	TFSY141A	11/16 17.5	21/32 16.7	2 1/8 54.0
1/2	TFSY161A	3/4 19.1	3/4 19.1	2 1/8 54.0
9/16	TFSY181A	13/16 20.6	13/16 20.6	2 3/8 60.3
5/8 (16)	TFSY201A	29/32 23	29/32 23	2 3/8 60.3
11/16	TFSY221A	31/32 24.6	31/32 24.6	2 5/8 66.7
3/4 (19)	TFSY241A	1 1/16 27.0	1 1/16 27.0	2 5/8 66.7
10	TFSY10A	19/32 15.1	19/32 15.1	2 1/8 54.0
12	TFSY12A	11/16 17.5	11/16 17.5	2 1/8 54.0
13	TFSY13A	3/4 19.1	3/4 19.1	2 1/8 54.0
14	TFSY14A	13/16 20.6	13/16 20.6	2 3/8 60.3
15	TFSY15A	13/16 20.6	13/16 20.6	2 3/8 60.3
17	TFSY17A	31/32 24.6	31/32 24.6	2 5/8 66.7

213TFSYA – 英制/公制螺旋状深套筒套件: 所有TFSY系列浅套筒(13件), 配塑料盘
209TFSMYA – 英制/公制螺旋状深套筒套件: TFSY10A至TFSY17A, 及TFSY141A, TFSY201A与TFSY241A(9件), 配塑料盘





213TFSMYA



FLANK DRIVE® 冲击套筒 3/8" 方头

万向冲击浅套筒

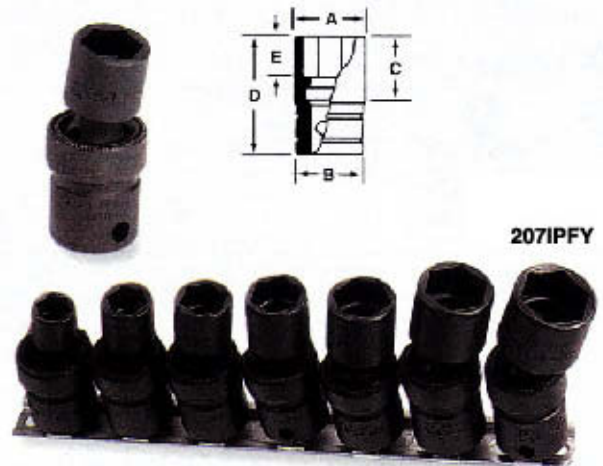

		A	B	C	D
3/8	IPF12B	9/16	7/8	1 31/32	1/4
7/16	IPF14B	21/32	7/8	2 1/16	9/32
1/2	IPF16B	3/4	7/8	2 1/8	5/16
9/16	IPF18B	13/16	7/8	2 3/16	5/16
5/8	IPF20B	7/8	7/8	2 1/4	11/32
11/16	IPF22B	31/32	29/32	2 17/32	13/32
3/4	IPF24B	1 1/16	29/32	2 19/32	7/16

207IPFY - 6角浅套筒套件: IPF12B至IPF24B(7件), 配A265滑轨与套筒夹



207IPFY

万向冲击浅套筒

			A	B	C	D
8	IPFM8B	-	13.2	22.2	49.8	6.4
9	IPFM9B	-	14.0	22.2	49.8	6.4
10	IPFM10B	IPDFM10	15.4	22.2	50.8	7.1
11	IPFM11B	-	16.7	22.2	52.1	7.1
12	IPFM12B	IPDFM12	18.1	22.2	53.1	7.1
13	IPFM13B	IPDFM13	18.9	22.2	54.1	7.9
14	IPFM14B	IPDFM14	20.5	22.2	55.4	7.9
15	IPFM15B	IPDFM15	21.2	22.2	56.4	7.9
16	IPFM16B	-	22.6	22.2	57.4	8.6
17	IPFM17B	-	23.4	23.0	62.2	8.6
18	IPFM18B	-	25.1	23.0	64.0	9.7
19	IPFM19B	-	26.4	23.0	65.0	10.4
22	IPFM22B	-	29.9	23.0	68.1	13.0



213IPFMY - 公制6角浅套筒套件: IPFM8B至IPFM22B(13件), 配A267滑轨与套筒夹
 211IPFMY - 公制6角浅套筒套件: IPFM9B至IPFM19B(11件), 配A267滑轨与套筒夹
 207IPFMY - 公制6角浅套筒套件: IPFM10B至IPFM19B(7件), 配A265滑轨与套筒夹
 205IPDFMY - 公制12角浅套筒套件: IPDFM8B至IPDFM15B(5件), 配A265滑轨与套筒夹

207IPFMY



207IPSFMY

万向冲击半深套筒

		A	B	C	D
8	IPSFM8	12.8	22.2	62.5	6.4
9	IPSFM9	14.0	22.2	63.0	7.1
10	IPSFM10	15.1	22.2	64.1	9.7
11	IPSFM11	17.2	22.2	65.6	9.7
12	IPSFM12	18.0	23.0	70.9	9.7
13	IPSFM13	19.6	23.0	71.9	10.4
14	IPSFM14	20.4	23.0	72.9	10.4
15	IPSFM15	22.0	23.0	74.4	10.4
16	IPSFM16	22.7	23.0	74.9	10.4
17	IPSFM17	24.3	23.0	76.0	11.2
18	IPSFM18	25.1	23.0	77.5	11.2
19	IPSFM19	26.7	23.0	79.0	14.2
22	IPSFM22	29.9	23.0	82.1	14.2
24	IPSFM24	32.1	23.0	84.8	14.7

214IPSFMY - 6角半深套筒套装: IPSFM8至IPSFM24(14件), 配A270滑轨与套筒夹
 207IPSFMY - 6角半深套筒套装: IPSFM10至IPSFM18 (IPSFM11及IPSFM16除外)(7件), 配A265滑轨与套筒夹

3/8" 方头 球形万向击套筒



深套筒

	6	A	B	C	D
3/8	IPLF12	9/16	7/8	2 15/16	1/4
7/16	IPLF14	21/32	7/8	3 1/32	9/32
1/2	IPLF16	3/4	7/8	3 1/8	5/16
9/16	IPLF18	13/16	7/8	3 3/16	5/16
5/8	IPLF20	7/8	7/8	3 1/4	11/32

205IPLFY-6角深套筒套件: IPLF12至IPLF20(5件), 配A265滑轨与套筒夹

深套筒

mm	6	A	B	C	D
8	IPLFM8A	15.8	24.9	70.1	9.1
10	IPLFM10A	15.8	24.9	70.1	9.1
12	IPLFM12A	16.6	24.9	70.1	9.7
13	IPLFM13	18.8	22.2	79.5	10.4
14	IPLFM14	20.4	22.2	81.0	10.4
15	IPLFM15	21.2	22.2	82.6	10.4
17	IPLFM17	23.4	23.0	88.3	10.2
18	IPLFM18	25.1	23.0	90.1	10.7
19	IPLFM19	26.7	23.0	91.2	14.2

209IPLFMY公制-6角冲击螺旋状深套筒套件: IPLFM8至IPLFM19(9件), 配A269滑轨与套筒夹上

冲击套筒附件



冲击延长杆

	A	B
IMX11	1/2	1 3/4
IMX31	1/2	3
IMX61	1/2	6
IMX111	1/2	11

204IMAX-冲击延长杆套装Im11至imx111(5件)(尺寸), 配塑料工具箱。



转接延长杆

	A	B	C	D
IMXA42	3/8	1/2	1/2	4



冲击球形万向套筒

	A	B
IPF80A*	1	2 1/8
IPF800A*	1	2 1/8

- 锁定扣保持力设计
- 摩擦珠保持力设计



1/2" 方头 常用套件 英制6角套件

317MSPC 6角镀铬套件, 配塑料盘

17件工具包括:

6角浅套筒:

TW121A	3/8"	TW221	11/16"	TW321	1"
TW141A	7/16"	TW241	3/4"	TW341	1 1/16"
TW161A	1/2"	TW261	13/16"	TW361	1 1/8"
TW181A	9/16"	TW281	7/8"		
TW201	5/8"	TW301	15/16"		

还包括:

- S936 密封棘轮扳手
- SN18B 18" 变向手柄
- SXK5 5" 延长杆
- SXK11 11" 延长杆

317MSPC



英制6角套件

321GTWB-6角工业处理常用套件(KRA280金属盒)

21件工具包括:

6角浅套筒:

GTW121A	3/8"	GTW261	13/16"
GTW141A	7/16"	GTW281	7/8"
GTW161A	1/2"	GTW301	15/16"
GTW181A	9/16"	GTW321	1"
GTW201	5/8"	GTW341	1 1/16"
GTW221	11/16"	GTW361	1 1/8"
GTW241	3/4"	GTW401	1 1/4"

还包括:

KB4	18 3/4" 快卸摇把
GU8	2 11/16" 万向接头
GS936	密封棘轮扳手
SN18B	18" 变向手把
GSXK3	3 1/2" 延长杆
GSXK5	5" 延长杆
GSXK11	11" 延长杆

321GTWB



英制12角套件

317MPC



317MPC-12角镀铬常用套件(塑料盘)

17件工具包括:

12角浅套筒:

SW121A	3/8"	SW201	5/8"	SW281	7/8"
SW141A	7/16"	SW221	11/16"	SW301	15/16"
SW161A	1/2"	SW241	3/4"	SW321	1"
SW181A	9/16"	SW261	13/16"	SW341	1 1/16"
				SW361	1 1/8"

还包括:

S936	密封棘轮扳手
SN18B	18" 变向手把
SXK5	5" 延长杆
SXK11	11" 延长杆

323GSWB-12角工业处理常用套件(KRA280金属盒)

23件工具包括:

12角浅套筒:

GSW121A	3/8"	GSW221A	11/16"	GSW341	1 1/16"
GSW141A	7/16"	GSW241A	3/4"	GSW361	1 1/8"
GSW161A	1/2"	GSW261A	13/16"	GSW381	1 3/16"
GSW181A	9/16"	GSW281A	7/8"	GSW401	1 1/4"
GSW191	19/32"	GSW301	15/16"		
GSW201	5/8"	GSW321	1"		

还包括:

KB4	18 3/4" 快卸摇把
GU8	2 11/16" 万向接头
GS936	密封棘轮扳手
GSXK3	3 1/2" 延长杆
GSXK5	5" 延长杆
GSXK11	11" 延长杆

323GSWB



325AMB



325AMB-12角镀铬常用套件, 配KRA280金属盒

25件工具包括:

12角浅套筒:

SW121A	3/8"	SW281	7/8"
SW141A	7/16"	SW301	15/16"
SW161A	1/2"	SW321	1"
SW181A	9/16"	SW341	1 1/16"
SW201	5/8"	SW361	1 1/8"
SW221	11/16"	SW381	1 3/16"
SW241	3/4"	SW401	1 1/4"
SW261	13/16"	SW421	1 5/16"

还包括:

S4	18 7/8" 快卸摇把
S8	2 11/16" 万向接头
S12L	12" 滑行T形扳手
S77	棘轮转接头
S936	密封棘轮扳手

SXK3	3 1/2" 延长杆
SXK5	5" 延长杆
SXK11	11" 延长杆

英制6角/12角套件

344AMB-镀铬常用套件(KRA280金属盒)

44件工具包括:

12角浅套筒:

SW121A	3/8"	SW281	7/8"	S161A	1/2"	S281	7/8"
SW141A	7/16"	SW301	15/16"	S181A	9/16"	S301	15/16"
SW161A	1/2"	SW321	1"	S201	5/8"	S321	1"
SW181A	9/16"	SW341	1 1/16"	S221	11/16"	S341	1 1/16"
SW201	5/8"	SW361	1 1/8"	S241	3/4"	S361	1 1/8"
SW221	11/16"	SW381	1 3/16"	S261	13/16"		
SW241	3/4"	SW401	1 1/4"				
SW261	13/16"	SW421	1 5/16"				

6角浅套筒:

307SUY 9/16" 至 15/16"(7件)

还包括:

S4	18 7/8" 快卸摇把
S8	2 11/16" 万向接头
S12L	12" 滑动T形扳手
S77	棘轮转接头
S936	密封棘轮扳手
SN18B	18" 变向手把
SX2	2" 延长杆
SXK5	5" 延长杆
SXK11	11" 延长杆
LRS70A	1 19/32" 棘轮旋转头

344AMB



1/2" 方头 常用套件

317AMMPC



317AMMPC-6角镀铬套件(塑料盘)

17件工具包括:

6角浅套筒:

TWM12A	12mm	TWM18	18mm
TWM13A	13mm	TWM19	19mm
TWM14A	14mm	TWM20	20mm
TWM15A	15mm	TWM21	21mm
TWM16	16mm	TWM22	22mm
TWM17	17mm	TWM23	23mm
		TWM24	24mm

还包括:

S936	密封棘轮扳手
SKK5	5" 延长杆
SXK11	11" 延长杆
SN18B	18" 变向手把

公制12角套件

345MMB



345MMB-12角工业处理常用套件(KRA280金属盒)

25件工具包括:

12角浅套筒:

323SWMY-公制12角浅套筒套件(23件)

10mm~32mm

313SMYA-公制12角深套筒套件(13件)

12mm~24mm

还包括:

S4	18 7/8" 快卸摇把
S8	2 11/16" 万向接头
S12L	12" 滑动T形扳手
S77	棘轮转接头
S936	密封棘轮扳手
SN18B	18" 变向手把
SXK3	2" 延长杆
SXK5	5" 延长杆
SXK11	11" 延长杆

325MMB



325MMB-12角工业处理常用套件(KRA280金属盒)

25件工具包括:

12角浅套筒:

SWM101A	10mm	SWM181	18mm
SWM111A	11mm	SWM191	19mm
SWM121A	12mm	SWM201	20mm
SWM131A	13mm	SWM211	21mm
SWM141A	14mm	SWM221	22mm
SWM151A	15mm	SWM231	23mm
SWM161	16mm	SWM241	24mm
SWM171	17mm	SWM251	25mm

还包括:

S4	18 7/8" 快卸摇把
S8	2 11/16" 万向接头
S12L	12" 滑动T形扳手
S77	棘轮转接头
S936	密封棘轮扳手
SXK3	3 1/2" 延长杆
SXK5	5" 延长杆
SXK11	11" 延长杆

360MB-6角/12角镀铬套件

60件工具包括:

12角浅套筒:

SW121A	3/8"	SW281	7/8"
SW141A	7/16"	SW301	15/16"
SW161A	1/2"	SW321	1"
SW181A	9/16"	SW341	1 1/16"
SW201	5/8"	SW361	1 1/8"
SW221	11/16"	SW381	1 3/16"
SW241	3/4"	SW401	1 1/4"
SW261	13/16"	SW421	1 5/16"

6角浅套筒:

307SUY 9/16" 至 15/16" (7件)

还包括:

A17	15/16" 扁套筒头
S9705K	13/16" 6角火花塞套筒
S12L	12" 滑动T形扳手
S77	棘轮转接头
SN18B	18" 变向手把
SX2	2" 延长杆
SXK3	3 1/2" 延长杆

6角浅套筒:

TS161A	1/2"	S161A	1/2"
TS181A	9/16"	S181A	9/16"
TS201	5/8"	S201	5/8"
TS221	11/16"	S221	11/16"
TS241	3/4"	S241	3/4"
TS261	13/16"	S261	13/16"
TS281	7/8"	S281	7/8"
TS301	15/16"	S301	15/16"
TS321	1"	S321	1"
TS341	1 1/16"	S341	1 1/16"
TS361	1 1/8"		

SXK5	5" 延长杆
SXK11	11" 延长杆
A80A	1/4" 到 1/2" 双头螺栓
LRS70A	1 19/32" 薄棘轮转接头
S936	密封棘轮扳手
SL936	大手柄密封棘轮扳手
S3	18 7/8" 快卸摇把
S8	2 11/16" 万向接头

英制6/12角套件

360MB



专用冲击套筒

PIT3120EB



PIT3120EB-冲击把套件

PIT160	冲击把
A26	3/4" 扁套筒头
SA10E	5/16" 内6角套筒螺丝刀头
SA12E	3/8" 内6角套筒螺丝刀头
SA14E	7/16" 内6角套筒螺丝刀头
SA16E	1/2" 内6角套筒螺丝刀头

SA18E	9/16" 内6角套筒螺丝刀头
SA18E	5/8" 内6角套筒螺丝刀头
SA18E	#3 十字套筒螺丝刀头
SA18E	#4 十字套筒螺丝刀头
SA18E	7/16" x .050 一字套筒螺丝刀头
SA18E	1/2" x .050 一字套筒螺丝刀头

棘轮扳手 1/2" 方头

Snap-on® 高强度密封棘轮扳手

专利设计，内部扩孔，高科技密封，特殊的O型环来密封永久的自身润滑，并将灰尘污垢、湿气、和其他污染物挡在外面。你将得到一个使用极其方便且无需日常维护的棘轮扳手。美国专利号：4,934,220 及 6,125,722。



Icon	Icon	Icon	Icon	Icon	Icon	A	B	C	Icon
高强度密封棘轮扳手									
S936 ▲	GS936 ▲	标准手柄	密封	-	36 10°	3/4	1 5/8	10 5/16	RKRS936
SL936 ▲	-	长手柄	密封	-	36 10°	3/4	1 5/8	15	RKRS936
SHL936A ▲	-	长软手柄	密封	红	36 10°	3/4	1 5/8	16 5/8	RKRS936
SF936 ▲	-	长带翻转头	密封	-	36 10°	3/4	1 5/8	17 21/32	RKRS936
SH936A ▲	-	软手柄	密封	红	36 10°	3/4	1 5/8	12	RKRS936
S936FOD ▲	-	FOD	密封	-	36 10°	3/4	1 5/8	10 5/16	RKRS936
密封棘轮头									
SX936	-	可锁定带翻转头	密封	-	36 10°	3/4	1 5/8	17 5/8	RKRS936

此棘轮扳手设计为防止在敏感环境的外来物损伤。
盖板用铆钉永久地与棘轮头部连接在一起，减少产生小碎片的机率。



RAT936-套件:
1/4", 3/8", 1/2" 方头棘轮扳手套件。
包括: T936, F936, S936

1/2" 方头 棘轮扳手

特别产品



				B	C	
SR936	-	36	10"	3/4	1 5/8	10 5/16
SA936*	-	36	10"	3/4	1 5/8	10 5/16
-	GSP936	36	10"	3/4	1 5/8	15 5/8
CFS949A†	-	49	7"	21/32	1 19/32	8 3/4

- 快卸棘轮扳手头部有一可推按钮来卸除已装在方头上的手动套筒。
- 支架式棘轮扳手自带一个套筒及头部为紧固件保护塑料罩。
- † 铲齿式棘轮扳手是理想的脚手架排孔与其他结构工作工具。当戴上后工作手套时，长回动手把提供简单的反作用力。锁定扭保持力。锥形直径为3/16" 至7/8"。锥长为8"。

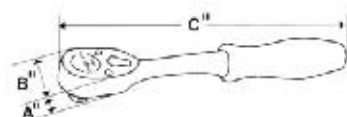

附件



转接头

		A	B	D
-	GSAF1E	1/2	3/8	1 1/2
A2A	GAF2A	3/8	1/2	1 5/16
-	GLA12B	1/2	3/4	1 7/8
-	GLA62A	3/4	1/2	3



复合材料(绝缘)转接头

每件工具都经过单独的测试，确保能防到1000伏电压。这些工具已经达到或是超过欧洲标准EN60900及IEC60900关于绝缘体强度测试与设计的要求，还有ASTM1505及VDE0680典型测试要求。这些工具已经达到或是超过ASME B107.1, ISO 1711和ISO 3315标准强度要求。非绝缘钢工具。

	A	B	C	D
CA1MF	3/8	1/2	1 5/16	3 25/32
CA2A	3/8	1/2	1	3 7/8

磁性转接头



	A	B	C	D
SXM212	9/32	21/32	1/2	2 21/32
SXM222	1/2	15/32	1/2	2 15/32

206XMSP-组合方头磁性转接头零件：包括1/4" 方头TMXM17和TMXM114转接头，3/8" 方头FXM18和FXM112转接头，及1/2" 方头SXM212和SXM222转接头(6件)，配滑轨与套筒夹

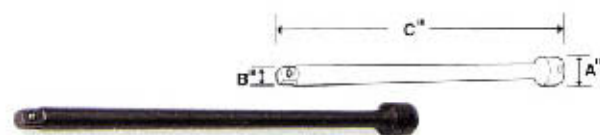

延长杆

	A	B	C
GAX5	1/2	3/8	5
GAX12	1/2	3/8	12
GAX24	1/2	3/8	23 1/4
GAX36	1/2	3/8	36



薄棘轮接头

	A	B
LRS70A	3/4	1 19/32

棘轮转接头

	A	B	
S77	20	18"	1 1/2
			2 9/16



警告：

- 请勿将镀铬或轻工业处理的手动工具应用于动力工具



附件 1/2" 方头



延长杆

		A	B
SX2	-	5/8	2 1/8
SXK3	GSXK3	5/8	3 1/2
SXK5	GSXK5	5/8	5
SXK8	-	5/8	8
SXK11	GSXK11	5/8	11
SX15	-	5/8	15
SX20	-	5/8	20
SX24	-	5/8	24
SX36	-	5/8	36

305ASX-套件：包括SX2-SXK11(共5件)



复合材料(绝缘)延长杆

每件工具都经过单独的测试，确保能防到1000伏电压。这些工具已经达到或是超过欧洲标准EN60900及IEC60900关于绝缘体强度测试与设计的要求，还有ASTM1505及VDE0680典型测试要求。这些工具已经达到或是超过ASME B107.1, ISO 1711和ISO 3315标准强度要求。非绝缘钢工具。美国专利号5,394,5,448,932及5,875,693。

	A	B	C
CSX5	1/2	1 5/16	5 21/32
CSX10	1/2	1 5/16	10 21/32

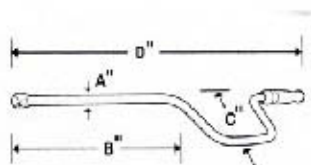
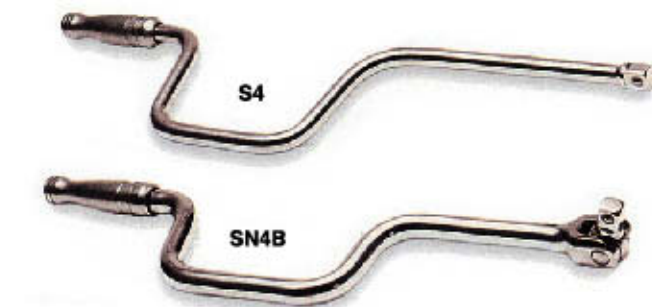

快卸摇把

	A	B	C	D
S4	1/2	7	4 3/8	18 7/8
SN4B	5/8	6 3/8	3	17 1/4



可摇摆延长杆

	A	B
SXWP2	5/8	2 1/16
SXWP3	5/8	3 1/2
SXWP5	5/8	5
SXWP8	5/8	7 27/32
SXWP11	5/8	11 3/16

204ASXW-套件：包括SXW2-SXW11(共5件)



1/2" 方头变向手柄

		标准	A	B	C
SN15B	GS15C	标准	1 1/8	15	5/8
SN18B	GSN18B	标准	1 1/8	18	5/8
SN24C	-	标准	1 1/8	24	5/8
SHBB24	-	软手柄	1 1/8	24	5/8
SN25A	-	45°偏斜角	1 1/8	24	5/8



T形滑动扳手

	A	B	C	
S12L	GS12L	1 11/16	5/8	12

万向接杆

	A	B	
S8	GU8	15/16	2 11/16

103UFTS-万向接头套件：包括1/4" 方头TMU8B, 3/8" 方头FU82及1/2" 方头S8万向接头(3件)，配塑料盘



1/2" 方头 套筒



TW241



GTW241



SW241



GSW241

浅套筒

	6	12	6	12	A	B	C	D	E
3/8	TW121A	SW121A	GTW121A	GSW121A	19/32	29/32	7/8	1 1/2	5/16
7/16	TW141A	SW141A	GTW141A	GSW141A	11/16	29/32	7/8	1 1/2	11/32
1/2	TW161A	SW161A	GTW161A	GSW161A	3/4	29/32	7/8	1 1/2	13/32
9/16	TW181A	SW181A	GTW181A	GSW181A	13/16	29/32	7/8	1 1/2	13/32
19/32	-	SW191A	-	GSW191A	7/8	29/32	7/8	1 1/2	13/32
5/8	TW201	SW201	GTW201	GSW201	15/16	7/8	7/8	1 1/2	15/32
11/16	TW221	SW221	GTW221	GSW221	31/32	29/32	7/8	1 1/2	1/2
3/4	TW241	SW241	GTW241	GSW241	1 1/32	1 1/16	7/8	1 1/2	9/16
13/16	TW261	SW261	GTW261	GSW261	1 1/8	1 1/16	7/8	1 1/2	9/16
7/8	TW281	SW281	GTW281	GSW281	1 3/16	1 1/8	7/8	1 1/2	9/16
15/16	TW301	SW301	GTW301	GSW301	1 9/32	1 7/32	27/32	1 17/32	3/4
1	TW321	SW321	GTW321	GSW321	1 11/32	1 9/32	7/8	1 9/16	3/4
1 1/16	TW341	SW341	GTW341	GSW341	1 7/16	1 3/8	1 31/32	1 11/16	3/4
1 1/8	TW361	SW361	GTW361	GSW361	1 1/2	1 7/16	1 31/32	1 3/4	1 1/16
1 3/16	TW381	SW381	-	GSW381	1 5/8	1 9/16	1 1/8	1 3/4	3/4
1 1/4	TW401	SW401	GTW401	GSW401	1 11/16	1 5/8	1 1/4	1 7/8	3/4
1 5/16	TW421	SW421	-	GSW421	1 3/4	1 11/16	1 1/4	1 7/8	1
1 3/8	TW441	SW441	-	GSW441	1 13/16	1 3/4	1 7/16	1 1/16	1
1 7/16	TW461	SW461	-	GSW461	1 15/16	1 7/8	1 5/8	1 1/4	1
1 1/2	TW481	SW481	-	GSW481	2	1 15/16	1 5/8	1 1/4	1

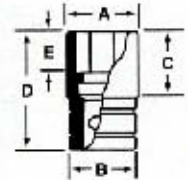

6角浅套筒套件:

319TWY-套筒套件: TW121A至TW481(19件), 配2个A270滑轨与套筒夹

313TWYA-套筒套件: TW121A至TW361(13件), 配A267滑轨与套筒夹

314GTWYA-套筒套件: GTW121A至GTW401(14件), 配A270滑轨与套筒夹

12角浅套筒套件:

319SWY-套筒套件: SW121A至SW481(19件), 配2个A270滑轨与套筒夹

313SWYA-套筒套件: SW121A至SW361(13件), 配A270滑轨与套筒夹

316GSWY-套筒套件: GSW121A至GSW421(除GSW191)(16件), 配A269滑轨与套筒夹



319TWY



314GTWYA



313SWYA



警告:



• 请勿将镀铬或经工业处理的手动工具应用在动力工具

套筒 1/2" 方头



浅套筒

mm	6	12	A	B	C	D	E
8	TWM8	-	12.2	22.9	21.4	38.1	6.4
9	TWM9	-	14.0	22.9	21.4	38.1	6.4
10	TWM10A	SWM101A	15.0	23.2	22.2	38.1	7.9
11	TWM11A	SWM111A	16.6	23.2	22.2	38.1	8.7
12	TWM12A	SWM121A	18.2	23.2	22.2	38.1	9.5
13	TWM13A	SWM131A	19.0	23.2	22.2	38.1	10.3
14	TWM14A	SWM141A	20.6	23.2	22.2	38.1	10.3
15	TWM15A	SWM151A	22.2	22.2	22.2	38.1	10.3
16	TWM16	SWM161	23.8	22.2	22.2	38.1	11.9
17	TWM17	SWM171	24.6	23.2	22.2	38.1	12.7
18	TWM18	SWM181	25.4	23.8	21.4	38.1	14.2
19	TWM19	SWM191	26.3	24.8	21.3	38.1	13.9
20	TWM20	SWM201	26.7	26.1	21.2	38.1	14.0
21	TWM21	SWM211	28.3	27.5	21.1	38.1	14.0
22	TWM22	SWM221	29.9	28.6	20.9	38.1	14.2
23	TWM23	SWM231	31.2	29.9	20.8	38.1	14.5
24	TWM24	SWM241	32.5	30.9	22.2	38.8	15.8
25	TWM25	SWM251	33.3	31.7	22.2	38.8	15.8
26	TWM26	SWM261	34.9	33.3	23.8	41.2	15.8
27	TWM27	SWM271	36.5	34.9	25.4	42.8	17.4
28	TWM28	SWM281	38.1	36.5	26.9	44.4	17.4
29	TWM29	SWM291	39.3	38.0	26.1	44.5	17.8
30	TWM30	SWM301	41.0	39.6	26.1	44.5	18.5
31	TWM31	SWM311	42.5	41.2	29.1	47.6	19.1
32	TWM32	SWM321	42.5	41.2	28.9	47.6	19.8
34	TWM34	-	42.5	41.2	29.1	47.6	19.8

公制6角浅套筒套件:

323TWMY: TWM10A至TWM32(23件), 配2个A270滑轨与套筒夹
 318TWMY: TWM10A至TWM27(18件), 配2个A269滑轨与套筒夹
 313TWMYA: TWM12A至TWM24(13件), 配A270滑轨与套筒夹
 310TWMYA: TWM10A至TWM19(10件), 配A269滑轨与套筒夹

公制12角浅套筒套件:

323SWMY: SWM101A至SWM321(23件), 配2个A270滑轨与套筒夹
 318SWMY: SWM101A至SWM271(18件), 配2个A269滑轨与套筒夹
 313SWMYA: SWM121A至SWM241(13件), 配A270滑轨与套筒夹
 310SWMYA: SWM101A至SWM191(10件), 配A269滑轨与套筒夹



深套筒

镀铬6角深套筒套件:

319TSY: TS121A至TS481(19件), 配2个A270滑轨与套筒夹

313TSYA: TS121A至TS361(13件), 配A267滑轨与套筒夹

工业处理6角深套筒套件:

315GTSY: GTS121A至GTS401(15件), 配A266滑轨与套筒夹

313GTSYA: GTS121A至GTS361(13件), 配A267滑轨与套筒夹

6角浅/深套筒套件:

326TSWA: 包括TW121A至TW361浅套筒加上TS121A至TS361深套筒(26件), 配塑料盘

镀铬12角深套筒套件:

319SY: S121A至S481(19件), 配2个A270滑轨与套筒夹

313SYA: S121A至S361(13件), 配A267滑轨与套筒夹

工业处理12角深套筒套件:

313GSY: GS161A至GS401(13件), 配A270滑轨与套筒夹

mm	6	12	6	12	A	B	C	D	E
3/8	TS121A	S121A	GTS121A	-	19/32	29/32	2 5/8	3 1/4	5/16
7/16	TS141A	S141A	GTS141A	-	3/4	29/32	2 5/8	3 1/4	11/32
1/2	TS161A	S161A	GTS161A	TS161A	3/4	29/32	2 5/8	3 1/4	13/32
9/16	TS181A	S181A	GTS181A	TS181A	13/16	29/32	2 5/8	3 1/4	13/32
5/8	TS201	S201	GTS201	TS201	15/16	7/8	1 31/32	3 1/4	15/32
11/16	TS221	S221	GTS221	TS221	31/32	29/32	1 31/32	3 1/4	1/2
3/4	TS241	S241	GTS241	TS241	1 1/32	31/32	2 5/8	3 1/4	9/16
13/16	TS261	S261	GTS261	TS261	1 1/8	1 1/16	2 5/8	3 1/4	9/16
7/8	TS281	S281	GTS281	TS281	1 3/16	1 1/8	2 5/8	3 1/4	9/16
15/16	TS301	S301	GTS301	TS301	1 9/32	1 7/32	1 31/32	3 1/4	3/4
1	TS321	S321	GTS321	TS321	1 11/32	1 9/32	1 31/32	3 1/4	3/4
1 1/8	TS341	S341	GTS341	TS341	1 7/16	1 3/8	1 31/32	3 1/4	3/4
1 1/8	TS361	S361	GTS361	TS361	1 1/2	1 7/16	1 31/32	3 1/4	1 3/16
1 3/16	TS381	S381	GTS381	TS381	1 5/8	1 9/16	2 5/8	3 1/4	1 3/16
1 1/4	TS401	S401	GTS401	TS401	1 11/16	1 5/8	2 5/8	3 1/4	1
1 5/16	TS421	S421	-	-	1 3/4	1 11/16	2 9/16	3 1/4	1
1 3/8	TS221	S221	-	-	1 13/13	1 3/4	2 9/16	3 1/4	1
1 7/16	TS261	S261	-	-	1 15/16	1 7/8	2 5/8	3 1/4	1
1 1/2	TS481	S481	-	-	2	1 15/16	2 5/8	3 1/4	1 1/16

1/2" 方头 套筒



深套筒

mm	6	12	A	B	C	D	E
10	TSM10A	SM10A	15.0	23.2	66.7	82.6	7.9
11	-	SM11A	16.6	23.2	66.7	82.6	8.7
12	TSM12A	SM12A	18.2	23.2	66.7	82.6	9.5
13	TSM13A	SM13A	19.0	23.2	66.7	82.6	10.3
14	TSM14A	SM14A	20.6	23.2	66.7	82.6	10.3
15	TSM15A	SM15A	22.2	22.2	66.7	82.6	10.3
16	TSM16	SM16	23.8	22.2	51.0	82.6	11.9
17	TSM17	SM17	24.6	23.2	51.0	82.6	12.7
18	TSM18	SM18	25.4	23.8	51.0	82.6	14.3
19	TSM19	SM19	26.3	24.6	52.5	82.6	14.2
20	TSM20	SM20	26.7	26.1	58.5	82.6	14.0
20.6	-	SM20.6	28.3	27.0	56.9	82.6	14.7
21	TSM21	SM21	28.3	27.5	58.5	82.6	14.0
22	TSM22	SM22	29.9	28.6	58.5	82.6	14.2
23	TSM23	SM23	31.2	29.9	58.5	82.6	14.5
24	TSM24	SM24	32.5	30.9	50.0	82.6	15.8
25	TSM25	SM25	33.3	31.7	50.0	82.6	15.8
26	TSM26	SM26	34.9	33.3	50.0	82.6	15.8
27	TSM27	SM27	36.2	34.9	50.0	82.6	17.5
28	TSM28	SM28	37.8	36.5	50.0	82.6	17.5
29	TSM29	SM29	39.3	38.0	64.3	82.6	17.5
30	TSM30	SM30	41.0	39.6	64.0	82.6	18.5
31	TSM31	SM31	42.5	41.2	64.0	82.6	19.1
32	TSM32	SM32	42.5	41.2	63.8	82.6	19.8

镀铬6角深套筒套件:

322TSMY-公制6角深套筒套件: TSM10A至TSM32(22件), 配2个A270滑轨与套筒夹

313TSMYA-公制6角深套筒套件: TSM12A至TSM24(13件), 配A270滑轨与套筒夹

310TSMYA-公制6角深套筒套件: TSM10A至TSM20(10件), 配A269滑轨与套筒夹

镀铬6角浅/深套筒套件:

320TSMWA-公制6角浅/深套筒套件包括TWM10A至TWM19浅套筒, 及TSM10A至TSM20深套筒(20件), 配塑料工具箱

镀铬12角深套筒套件:

323SMY-公制12角深套筒套件: SM10A至SM32(23件), 配2个A270滑轨与套筒夹

313SMYA-公制12角深套筒套件: SM12A至SM24(除20.6)(13件), 配A270滑轨与套筒夹

310SMYA-公制12角深套筒套件: SM10A至SM19(10件), 配A269滑轨与套筒夹

SU24

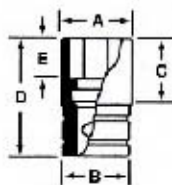
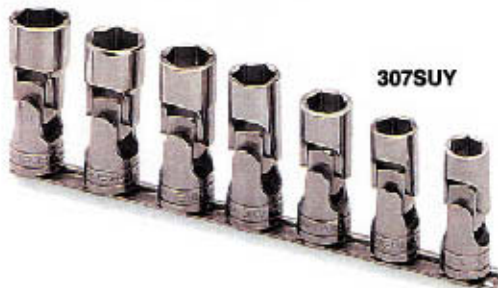

万向套筒

mm	6	A	B	C	D
9/16	SU18	27/32	15/16	2 7/16	11/32
5/8	SU20	15/16	15/16	2 15/32	3/8
11/16	SU22	1 1/16	1 1/16	2 9/16	7/16
3/4	SU24	1 1/8	1 1/8	2 7/8	1/2
13/16	SU26	1 3/16	1 1/8	2 15/16	9/16
7/8	SU28	1 1/4	1 1/8	2 15/16	9/16
15/16	SU30	1 5/16	1 1/8	3	9/16

307SUY-套件: 包括SU18-SU30(共7件)(9/16" 至15/16"), 配A269滑轮与套筒夹



警告:



• 请勿将镀铬或轻工业处理的手动工具应用在动力工具

专用套筒 1/2" 方头

双四方套筒

		A	B	C	D	E
3/8	SW412	23/32	7/8	7/8	1 1/2	5/16
7/16	SW414	51/64	7/8	7/8	1 1/2	3/8
1/2	SW416	29/32	7/8	7/8	1 1/2	13/32
9/16	SW418	31/32	29/32	7/8	1 1/2	7/16
5/8	SW420	1 1/16	1	7/8	1 1/2	1/2
11/16	SW422	1 3/16	1 1/8	7/8	1 1/2	1/2
3/4	SW424	1 9/32	1 3/16	7/8	1 1/2	9/16
13/16	SW426	1 7/16	1 3/8	1	1 5/8	5/8
7/8	SW428	1 1/2	1 7/16	1 1/8	1 3/4	5/8
15/16	SW430	1 5/8	1 9/16	1 1/8	1 13/16	11/16
1	SW430	1 11/16	1 5/8	1 1/4	1 7/8	11/16

ASME/ANSI B107.1-1993

311ASQY-套件: 包括SW412-SW432(11件)(3/8"至1"), 配A267滑轮与套筒夹

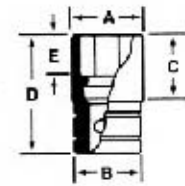

浅TORX®套筒

		A	B	C
E12	SLE120	19/32	7/8	1 1/2
E14	SLE140	21/32	7/8	1 1/2
E16	SLE160	23/32	27/32	1 1/2
E18	SLE180	27/32	7/8	1 1/2
E20	SLE200A	15/16	7/8	1 1/2
E24	SLE240	1 1/16	1	1 1/2



WEATHERHEAD® 套筒

		A	B
7/8	WH280	1 3/8	1 13/16
29/32	WH290	1 7/16	1 13/16
15/16	WH300	1 1/2	1 13/16



一字套筒头

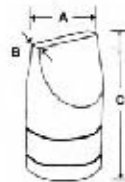

	A	B	C
A26	3/4	.109	1 11/16
A17	15/16	.150	1 11/16
A15	1 3/16	.150	1 11/16



堵头

A	B	C
1/2 PPM516A	15/16	1 7/16

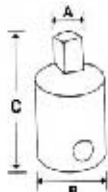

FLANK DRIVE® 五角形套筒

套筒专面对五角螺钉, 使用防损材质, 使用在石化、电力及水工业厂, 专门保护门栓。

	A	B	C
B2191	1 1/8	1/2	1 1/16



FLANK DRIVE® 火花塞套筒

	A	B
13/16 S9705K	7/8	2 1/2 S9705A2

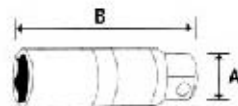

FLANK DRIVE® 火花塞(弹簧圈)

	A	B
7/8 S6106KA	7/8	3 1/2 S6106-2R

1/2" 方头 套筒螺丝刀头

307ESAY



307ESAMY



内六角螺丝刀头

尺寸	零件号	零件号	A	B
5/16	SA10E	GSA10E	2 3/8	FA10E2
3/8	SA12E	GSA12E	2 1/2	SA12E2
7/16	SA14E	GSA14E	2 7/8	SA14E2-2
1/2	SA16E	GSA16E	3 1/15	SA16E2
9/16	SA18E	GSA18E	3 3/16	SA18E2
5/8	SA20E	GSA20E	3 11/32	LAW120E2
3/4	SA24E	GSA24E	4 1/16	LAW120E2

镀铬套件:

307ESAY-套件: SA10E-SA24E(7件)(5/16"至3/4"), 配A269滑轨与套筒夹

工业处理套件:

307EGSAY-黑色套件: GSA10E-GSA24E(7件)(5/16"至3/4"), 配A269滑轨与套筒夹

内六角螺丝刀头

mm	零件号	A	B
6	SAM6E	60.5	FAM6E
8	SAM8E	62.0	FAM8E2
10	SAM10E	62.8	SAM10E2-5
12	SAM12E	81.0	SAM12E2
14	SAM14E	81.0	SAM14E2
17	SAM17E	93.7	SAM17E2
19	SAM19E	103.1	SAM19E2

307ESAMY-套件, SA6E-SA19E(7件)(6至19mm), 配A265滑轨与套筒夹

一字头螺丝刀头

尺寸	零件号	A	B
7/16" X.050	SW28E	3 1/16	SW28E2
1/2" X.075	SW32E	3 1/16	SW32E2
5/8" X.093	SW40E	3 1/4	SE40E2

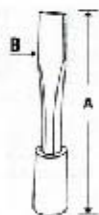

十字头螺丝刀头

#	零件号	A	B
#3	SP32E	2 3/16	SP32E2
#4	SP42E	2 5/16	SP42E2

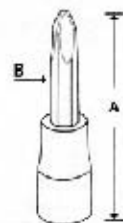

TORX® 螺丝刀头

#	零件号	A	B
标准:			
T55	STX55E	2 9/16	FTX55E2
T60	STX60E	3 11/32	STX60E2
加长:			
T45	STXL45E	4 5/8	STXL45E2
T50	STXL50E	4 5/8	STXL50E2
T55	STXL55E	4 5/8	STXL55E2
T60	STXL60E	4 5/8	STXL60E2



三四方刀头套筒螺丝刀

mm	零件号	A	B
10	STSM10E	88.9	STSM10E2
12	STSM12E	109.5	STSM12E2
12	STSM12LE	147.6	STSM12LE2

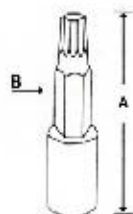

警告:



• 请勿将镀铬及工业处理的手动工具应用于动力工具

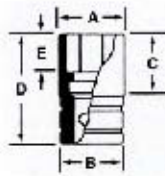

浅套筒

尺寸	6	12	A	B	C	D	E
3/8	P120A	-	19/32	29/32	7/8	1 1/2	5/8
7/16	P140A	PDH140A	23/32	29/32	7/8	1 1/2	11/32
1/2	P160A	PDH160A	3/4	29/32	7/8	1 1/2	13/32
9/16	P180A	PDH180A	7/8	29/32	7/8	1 1/2	13/32
5/8	P200	PDH200	15/16	1	7/8	1 1/2	15/32
11/16	P220	PDH220	1 1/16	1 1/16	7/8	1 1/2	1/2
3/4	P240	PDH240	1 1/8	1 1/8	7/8	1 1/2	1/2
13/16	P260	-	1 1/4	1 1/4	7/8	1 1/2	1/2
7/8	P280	PDH280	1 5/16	1 5/16	3/16	1 1/2	9/16
15/16	P300A	-	1 3/8	1 3/8	1 1/16	1 3/4	3/4
1 1/16	P340A	-	1 9/16	1 9/16	1 3/8	2	25/32

浅套筒

mm	6	A	B	C	D	E
13	PM13A	19.0	22.2	22.2	38.1	10.3
15	PM15A	22.2	23.2	22.2	38.1	10.3
17	PM17	24.6	24.6	22.2	38.1	12.7
18	PM18	25.4	25.4	22.2	38.1	14.2
19	PM19	26.4	26.4	21.3	38.1	11.5
21	PM21	28.3	28.3	21.3	38.1	11.9
24	PM24	32.5	32.5	21.4	38.8	15.8

深套筒

尺寸	6	A	B	C	D	E
7/16	SP140a	23/32	29/32	2 5/8	3 1/4	11/32
1/2	SP160A	3/4	29/32	2 5/8	3 1/4	13/32
9/16	SP180A	7/8	29/32	2 5/8	3 1/4	13/32
5/8	SP200	13/32	29/32	2 5/8	3 1/4	13/32
11/16	SP220	1 1/16	1 1/16	2 5/8	3 1/4	1/2
3/4	SP240	1 1/8	1 1/8	2 5/8	3 1/4	9/16
13/16	SP260	1 1/4	1 1/4	2 5/8	3 1/4	19/32
7/8	SP280	1 5/8	1 5/8	2 3/32	3 1/2	9/16
15/16	SP300A	1 3/8	1 3/8	2 3/32	3 1/2	3/4
1	SP320A	1 7/16	1 7/16	2 3/32	3 1/2	3/4

深套筒

mm	6	A	B	C	D	E
13	SPM13A	19.0	22.2	66.6	82.6	10.3
15	SPM15A	22.2	22.2	66.6	82.6	10.3
17	SPM17	24.6	24.6	66.6	82.6	12.7
18	SPM18	25.4	25.4	66.6	82.6	14.2
19	SPM19	26.4	26.4	64.8	82.6	11.9
21	SPM21	28.3	28.3	64.8	82.6	12.3
24	SPM24	32.5	32.5	50.0	82.6	15.8

307SPMY-公制6角深套筒零件: 包括 SPM13A-SPM24(7件)(13至24mm), 配A265滑轨与套筒夹

表面驱动套筒



表面驱动头套筒使用在工业领域中的组装流水线, 特殊的斜面与设计使得套筒在一个动力螺母安装器上转动时与紧固件啮合。美国专利号: 4,512,220。



浅套筒

尺寸	A	B	C	D	E	
1/2	DT16A	3/4	29/32	27/32	1 1/2	13/32
9/16	DT18A	13/16	29/32	27/32	1 1/2	13/32
5/8	DT20A	15/16	15/16	27/32	1 1/2	1/2
3/4	DT24A	1 1/32	1 1/32	13/16	1 1/2	9/16
15/16	DT30A	1 9/32	1 9/32	27/32	1 17/32	3/4

浅套筒

mm	A	B	C	D	E	
13	DTM13A	19.3	22.9	21.3	38.1	9.4
15	DTM15A	22.3	22.9	21.3	38.1	10.7
18	DTM18A	25.3	25.3	21.3	38.1	14.0

深套筒

尺寸	A	B	C	D	E	
1/2	DTS16A	3/4	29/32	2 19/32	3 1/4	13/32
9/16	DTS18A	13/16	29/32	2 19/32	3 1/4	13/32
5/8	DTS20A	15/16	15/16	2 1/8	3 1/4	1/2
3/4	DTS24A	1 1/32	1 1/32	2 5/16	3 1/4	5/8

深套筒

mm	A	B	C	D	E	
13	DTSM13A	19.3	21.8	65.8	82.6	10.2
15	DTSM15A	22.3	21.8	65.8	82.6	10.7
18	DTSM18A	25.3	25.3	57.6	82.6	14.0

1/2" 方头 机用套筒

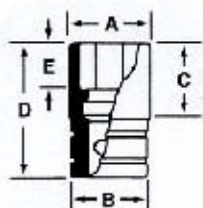

双四方浅套筒

尺寸	零件号	A	B	C	D	E
3/8	P412	13/32	7/8	7/8	1 1/2	5/16
7/16	P414	13/16	15/16	7/8	1 1/2	3/8
1/2	P416	29/32	1	7/8	1 1/2	13/32
9/16	P418	1	1 1/8	7/8	1 1/2	1/2
5/8	P420	1 3/32	1 3/16	7/8	1 1/2	1/2
11/16	P422	1 7/32	1 1/4	7/8	1 1/2	13/32
3/4	P424	1 5/16	1 3/8	7/8	1 1/2	9/16
13/16	P426	1 7/16	1 7/16	7/8	1 1/2	5/8
7/8	P428	1 1/2	1 1/2	7/8	1 1/2	5/8
1	P432	1 23/32	1 23/32	1 1/8	1 3/4	3/4

310PY-8角套件：包括P412-P432(10件)(3/8"至1")，配2个A269滑轨与套筒夹。

双四方机用浅套筒

尺寸	零件号	A	B	C	D	E
5/8	SIPR420	1 1/8	1 1/8	2 9/16	3 1/4	1/2
3/4	SIPR424	1 5/16	1 1/8	2 5/8	3 1/4	1/2
13/16	SIPR426	1 7/16	1 3/8	2 9/16	3 1/4	5/8
7/8	SIPR428	1 9/16	1 3/8	2 25/32	3 1/2	21/32
1	SIPR432	1 3/4	1 1/2	2 11/16	3 1/2	3/4
1 1/16	SIPR434	1 7/8	1 3/4	2 3/4	3 1/2	25/32
1 1/8	SIPR436	1 15/16	1 1/2	2 23/32	3 1/2	27/32



双四方特深套筒

尺寸	零件号	A	B	C	D	E
1 1/8	SIPRL436	1 15/16	1 1/2	4 13/32	5	27/32



磁性六角动力套筒

尺寸	零件号	A	B	D	E
3/8	MPK121A	19/32	7/8	1 1/2	1/8
7/16	MPK141A	11/16	7/8	1 1/2	5/32
1/2	MPK161A	25/32	15/16	1 1/2	5/32
9/16	MPK181A	7/8	15/16	1 1/2	5/32



TORX® 套筒

尺寸	零件号	A	B	C
E10	PSLE100	1/2	7/8	1 1/2
E12	PSLE120A	19/32	29/32	1 1/2
E14	PSLE140A	21/32	29/32	1 1/2

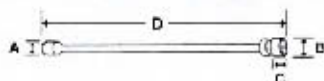

FLANK DRIVE® 可翻转延长杆套筒

尺寸	零件号	A	B	C	D
15	PSXM915	25.1	21.6	10.7	253.9



警告：



• 请勿将镀铬及工业处理的手动工具应用于动力工具

机用套筒



内六角套筒

#	Part	A	B
5/16	PSA10E	2 7/16	FA10E2
3/8	PSA12E	2 9/16	SA12E2
7/16	PSA14E	2 7/8	SA14E2-2
1/2	PSA16E	3 1/16	SA16E2
9/16	PSA18E	3 1/8	SA18E2
5/8	PSA20E	3 7/16	LAW120E2
3/4	PSA24E	4 1/16	LAW124E2

307PSAY-套件。包括PSA10E-PSA24E(7件)(5/16"至3/4")，配A265滑轨与套筒夹。



TORX® 套筒

#	Part	A	B
T45	PSTX45E	2 7/16	FTX45E2
T50	PSTX50E	2 9/16	FTX50E2
T47	PSTX500E*	2 7/8	FTX500E2
T55	PSTX55E	3 1/16	FTX55E2

210EPTXY-TORX® 套筒螺丝刀头零件：
包括1/4"方头PTTX15E至PTTX25E套筒螺丝刀头，3/8"方头PFTX27E至PFTX40E套筒螺丝刀头，及1/2"方头PSTX45E、PSTX50E及PSTX500E套筒螺丝刀头(10件)(T15至T55)，配A269滑轨与套筒夹

机用套筒附件



可锁机用转接头

Part	A	B	C	D
PA2A	3/8	1/2	3/4	1 5/16
PA4A	1/2	3/8	15/16	1 15/32

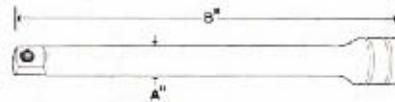
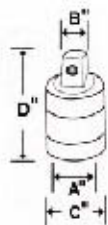

可锁机用延长杆

Part	A	B
PS2	5/8	2
PS3	5/8	3 1/2
PS5	5/8	5
PS10	5/8	10

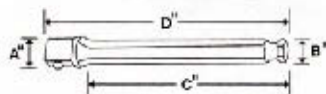

六角接杆

Part	A	B	C	D
A3011A	1/2	7/16	1 1/4	2 3/4
A3012A	1/2	7/16	1 1/4	5
A3021A	1/2	5/8	1 1/4	2 3/4



浅套筒

#	6	12	A	B	C	D	E
3/8	IML120	IMDL120	19/32	29/32	7/8	1 1/2	5/16
7/16	IML140	IMDL140	23/32	29/32	7/8	1 1/2	11/16
1/2	IML160	IMDL160	13/16	29/32	7/8	1 1/2	13/32
9/16	IML180	IMDL180	7/8	29/32	7/8	1 1/2	13/32
5/8	IML200	IMDL200	15/16	1	7/8	1 1/2	15/32
11/16	IML220	IMDL220	1 1/16	1 1/16	3/4	1 1/2	1/2
3/4	IML240	IMDL240	1 1/8	1 1/8	3/4	1 1/2	1/2
13/16	IML260	IMDL260	1 1/4	1 1/4	3/4	1 1/2	1/2
7/8	IML280	IMDL280	1 5/16	1 5/16	1 1/16	1 1/2	9/16
15/16	IML300	IMDL300	1 3/8	1 3/8	1 1/16	1 1/2	3/4
1	IML320	IMDL320	1 7/16	1 7/16	1	2	3/4
1 1/16	IML340	—	1 9/16	1 9/16	1	2	13/16
1 1/8	IML360	IMDL360	1 5/8	1 5/8	1 3/32	2	13/16
1 3/16	IML380	—	1 11/16	1 1/2	1 5/32	2	13/16
1 1/4	IML400	IMDL400	1 3/4	1 1/2	1 3/8	2	13/16
1 5/16	IML420	—	1 7/8	1 1/2	1 3/8	2	7/8
1 3/8	IML440	—	1 15/16	1 1/2	1 3/8	2	7/8
1 7/16	IML460	—	2	1 1/2	1 3/8	2	15/16
1 1/2	IML480	—	2 1/8	1 9/16	1 3/8	2	15/16
1 9/16	IML500	—	2 1/4	1 5/8	1 11/16	2 5/16	15/16

6角套筒零件:

320IMYLM-浅套筒零件: IML120至IML500(20件), 配2个A270滑轨与套筒夹
311IMYLM-浅套筒零件: IML120至IML320(11件), 配A267滑轨与套筒夹

12角套筒零件:

313IMDLM-浅套筒零件: IMDL120至IMDL400(14件), 配A267滑轨与套筒夹
307IMDLM-浅套筒零件: IMDL120至IMDL240(7件), 配A269滑轨与套筒夹

FLANK DRIVE® 冲击套筒



1/2"方头 FLANK DRIVE® 冲击套筒

浅套筒



1/2" 方头	6	12	A	B	C	D	E
10	IMML100	IMDML100	15.0	22.6	22.2	38.1	7.9
11	IMML110	IMDML110	18.2	22.6	22.2	38.1	8.7
12	IMML120	IMDML120	19.0	24.3	22.2	38.1	9.5
13	IMML130	IMDML130	20.6	24.3	22.2	38.1	10.3
14	IMML140	IMDML140	22.2	24.3	22.2	38.1	10.3
15	IMML150	IMDML150	23.8	26.4	22.2	38.1	10.3
16	IMML160	IMDML160	24.6	26.4	22.2	38.1	11.9
17	IMML170	IMDML170	25.4	26.7	22.2	38.1	12.7
18	IMML180	IMDML180	26.7	26.7	19.1	38.1	12.7
19	IMML190	IMDML190	28.3	28.3	21.3	38.1	12.7
20	IMML200	IMDML200	29.9	29.9	21.1	38.1	14.2
21	IMML210	IMDML210	31.5	31.5	21.0	38.1	14.2
22	IMML220	IMDML220	33.3	33.3	21.4	38.1	15.9
23	IMML230	IMDML230	34.1	34.1	27.8	44.5	15.9
24	IMML240	IMDML240	34.9	34.9	27.8	44.5	15.9
25	IMML250	-	29.9	29.8	27.0	44.5	15.9
26	IMML260	-	38.1	38.1	33.3	50.8	15.9
27	IMML270	-	39.4	39.4	27.1	50.8	20.3
29	IMML290	-	41.1	41.1	33.3	50.8	21.1
30	IMML300	-	42.7	42.7	32.1	50.8	21.6
32	IMML320	-	45.8	45.8	32.1	50.8	22.4
34	IMML340	-	47.6	42.9	40.5	52.4	22.4
36	IMML360	-	50.8	45.8	40.5	57.2	22.4
46	IMML460	-	47.6	47.6	50.3	69.9	29.7

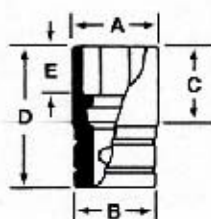

6角套筒套件:

323IMMYLM-公制6角浅套筒套件: IMML100至IMML460(除imml340)(23件), 配2个A270滑轨与套筒夹

315IMMYLM-公制6角浅套筒套件: IMML100至IMML240(15件), 配A270滑轨与套筒夹

310IMMYLM-公制6角浅套筒套件: IMML100至IMML190(10件), 配A269滑轨与套筒夹

12角套筒套件:

315IMDMYLM-公制12角套筒套件: IMDML100至IMDML240(15件), 配A270滑轨与套筒夹

薄壁浅冲击套筒

1/2" 方头	6	A	B	C	D	E
3/8	IMFS120	19/32	7/8	3/8	1 1/2	7/32
7/16	IMFS140	11/16	7/8	9/16	1 1/2	11/32
1/2	IMFS160	3/4	7/8	5/8	1 1/2	3/8
9/16	IMFS180	13/16	7/8	11/16	1 1/2	13/32
5/8	IMFS200	29/32	29/32	3/4	1 1/2	15/32
11/16	IMFS220	1	1	13/16	1 1/2	1/2
3/4	IMFS240	1 1/16	1 1/16	13/16	1 1/2	1/2
13/16	IMFS260	1 1/8	1 1/8	25/32	1 1/2	1/2
7/8	IMFS280	1 7/32	1 7/32	29/32	1 5/8	9/16
15/16	IMFS300	1 5/16	1 5/16	1 3/16	2	3/4
1	IMFS320	1 3/8	1 3/8	1 3/16	2	3/4
1 1/16	IMFS340	1 7/16	1 7/16	1 1/4	2	13/16
1 1/8	IMFS360	1 1/2	1 1/2	1 1/4	2	13/16
1 3/16	IMFS380	1 5/8	1 5/8	1 1/4	2 1/16	13/16
1 1/4	IMFS400	1 11/16	1 11/16	1 1/4	2 1/16	13/16
1 5/16	IMFS420	1 3/4	1 3/4	1 1/4	2 1/16	13/16
1 3/8	IMFS440	1 13/16	1 13/16	1 1/4	2 1/16	13/16
1 7/16	IMFS460	1 29/32	1 29/32	1 3/8	2 1/16	13/16
1 1/2	IMFS480	2	2	1 3/8	2 1/16	13/16

319IMFSY-6角浅套筒套件: IMFS120至IMF480(19件), 配2个A270滑轨与套筒夹

311IMFSY-6角浅套筒套件: IMFS120至IMF320(11件), 配A267滑轨与套筒夹





警告:



• 请勿将机用工具及附件用于冲击工具使用

FLANK DRIVE® 冲击套筒 1/2" 方头

深套筒

		A	B	C	D	E
3/8	SIMLM120	19/32	29/32	2 5/8	3 1/4	5/16
7/16	SIMLM140	23/32	29/32	2 5/8	3 1/4	11/32
1/2	SIMLM160	13/16	29/32	2 5/8	3 1/4	3/8
9/16	SIMLM180	7/8	29/32	2 5/8	3 1/4	13/32
5/8	SIMLM200	31/32	29/32	2 5/8	3 1/4	15/32
11/16	SIMLM220	1 1/16	1 1/16	2 5/8	3 1/4	1/2
3/4	SIMLM240	1 1/8	1 1/8	2 5/8	3 1/4	9/16
13/16	SIMLM260	1 1/4	1 1/4	2 5/8	3 1/4	19/32
7/8	SIMLM280	1 5/16	1 5/16	2 3/32	3 1/2	9/16
15/16	SIMLM300	1 3/8	1 3/8	2 3/32	3 1/2	3/4
1	SIMLM320	1 7/16	1 7/16	2 5/8	3 1/2	3/4
1 1/16	SIMLM340	1 9/16	1 9/16	2 11/16	3 1/2	25/32
1 1/8	SIMLM360	1 5/8	1 5/8	2 11/16	3 1/2	25/32
1 1/4	SIMLM380	1 11/16	1 1/2	2 11/16	3 1/2	25/32
1 5/16	SIMLM400	1 7/8	1 1/2	2 11/16	3 1/2	1
1 3/8	SIMLM420	2	1 1/2	2 11/16	3 1/2	15/16
1 7/16	SIMLM440	2	1 1/2	2 21/32	3 1/2	15/16
1 1/2	SIMLM460	2 1/8	1 9/16	2 5/8	3 1/2	15/16
1 9/16	SIMLM480	2 1/4	1 5/8	2 5/8	3 1/2	15/16



320SIMYLM-6角深套筒套件: SIMLM120至SIMLM500(20件), 配2个A270滑轨与套筒夹

313SIMLM-6角深套筒套件: SIMLM160至SIMLM400(13件), 配A270滑轨与套筒夹

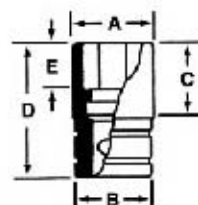
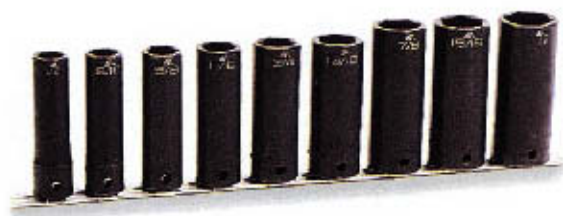
309SIMYLM-6角深套筒套件: SIMLM160至SIMLM320(9件), 配A270滑轨与套筒夹



深套筒

		A	B	C	D	E
10	SIMMLM100	15.0	23.2	66.7	82.6	7.9
11	SIMMLM110	18.2	23.2	66.7	82.6	8.7
12	SIMMLM120	19.0	23.2	66.7	82.6	9.5
13	SIMMLM130	20.6	23.2	66.7	82.6	10.3
14	SIMMLM140	22.2	23.2	66.7	82.6	10.3
15	SIMMLM150	23.8	23.8	50.0	82.6	10.3
16	SIMMLM160	24.6	24.6	50.0	82.6	11.9
17	SIMMLM170	25.1	25.1	57.9	82.6	11.2
18	SIMMLM180	26.7	26.7	61.0	82.6	12.7
19	SIMMLM190	28.3	28.3	61.0	82.6	14.2
20	SIMMLM200	29.9	29.9	61.0	82.6	14.2
21	SIMMLM210	31.5	31.5	61.0	82.6	14.2
22	SIMMLM220	33.1	33.1	71.6	88.9	15.7
23	SIMMLM230	33.1	33.1	64.3	88.9	15.9
24	SIMMLM240	34.9	34.9	63.5	88.9	15.9
25	SIMMLM250	36.5	36.5	63.5	88.9	15.9
26	SIMMLM260	34.9	33.3	50.0	88.9	19.8
27	SIMMLM270	39.4	39.4	71.0	88.9	20.3
29	SIMMLM290	41.3	41.3	71.6	88.9	21.3
30	SIMMLM300	42.9	42.9	71.1	88.9	21.6
32	SIMMLM320	45.8	45.8	71.1	88.9	22.4
33	SIMMLM330	46.0	44.5	72.8	88.9	22.4
34	SIMMLM340	49.3	44.5	72.8	88.9	22.6
35	SIMMLM350	50.8	45.8	72.8	88.9	22.9
36	SIMMLM360	50.8	45.8	72.8	88.9	22.9



324SIMMYLM-公制6角深套筒套件: SIMMLM100至SIMMLM360(24件), 配2个A270滑轨与套筒夹

315SIMMYLM-公制6角深套筒套件: SIMMLM100至SIMMLM240(15件), 配A270滑轨与套筒夹

310SIMMYLM-公制6角深套筒套件: SIMMLM100至SIMMLM190(10件), 配A269滑轨与套筒夹

305SIMMYLM-公制6角深套筒套件: SIMMLM290、SIMMLM300、SIMMLM340、SIMMLM350、及SIMMLM360(5件), 配A269滑轨与套筒夹

1/2" 方头 FLANK DRIVE® 冲击套筒

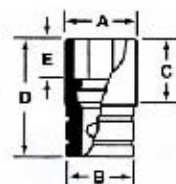

加深套筒

1/2"	6	A	B	C	D	E
1/2	SIML160*	25/32	15/16	4 1/4	5	3/8
9/16	SIML180	7/8	15/16	4 1/4	5	13/32
5/8	SIML200	31/32	1	4 1/4	5	15/32
11/16	SIML220	1 1/16	1 1/16	4 1/4	5	1/2
3/4	SIML240	1 1/8	1 1/8	4 1/4	5	9/16
13/16	SIML260	1 1/4	1 1/4	4 1/4	5	19/32
7/8	SIML280	1 5/16	1 5/16	4 1/4	5	21/32
15/16	SIML300	1 3/8	1 3/8	4 1/4	5	23/32
1	SIML320	1 7/16	1 7/16	4 3/8	5	3/4
1 1/16	SIML340	1 9/16	1 9/16	4 3/8	5	25/32
1 1/8	SIML360	1 5/8	1 5/8	4 3/8	5	25/32

*: 用于拆除与更换油箱挡板螺母。同时也应用于紧急刹车调节和水平尾翼防松螺母。
311SIML-6角超深套筒套件: SIML160至SIML360(11件)



加深套筒

mm	6	A	B	C	D
12	SIMML120	18.9	24.3	91.4	9.7
13	SIMML130	19.8	24.3	91.4	10.4
15	SIMML150	23.2	26.4	91.4	10.7



球底万向浅冲击套筒

1/2"	6	A	B	D	E
1/2	IPL16B	3/4	15/16	2 29/32	11/32
9/16	IPL18B	13/16	15/16	2 29/32	11/32
5/8	IPL20B	7/8	15/16	2 29/32	11/32
11/16	IPL22B	31/32	1 3/16	3 1/16	13/32
3/4	IPL24B	1 1/32	1 3/16	3 1/16	7/16
13/16	IPL26B	1 1/8	1 3/16	3 1/16	1/2
7/8	IPL28B	1 3/16	1 3/16	3 1/16	9/16
15/16	IPL30B	1 9/32	1 3/16	3 1/16	5/8
1	IPL32B	1 11/32	1 3/16	3 1/16	11/16
1 1/16	IPL34B	1 7/8	1 3/16	3 5/32	11/16
1 1/8	IPL36B	1 1/2	1 3/16	3 11/32	3/4
1 3/16	IPL38B	1 9/16	1 3/16	3 11/32	3/4
1 1/4	IPL40B	1 5/8	1 3/16	3 13/32	16/16
1 5/16	IPL42B	1 3/4	1 3/16	3 13/32	7/8

314IPLY-6角浅套筒套件: IPL16B至IPL42B(14件), 配A270滑轨与套筒夹
305IPLY-6角浅套筒套件: IPL16B至IPL24B(5件), 配A265滑轨与套筒夹
304IPLY-6角浅套筒套件: PL26B至IPL32B(4件), 配A270滑轨与套筒夹

球底万向深冲击套筒

1/2"	6	A	B	C	D
1/2	SIP16	3/4	1 3/16	3 23/32	11/32
9/16	SIP18	13/16	1 3/16	3 13/16	11/32
5/8	SIP20	7/8	1 3/16	3 15/16	11/32
11/16	SIP22	31/32	1 3/16	4 5/32	13/32
3/4	SIP24	1 1/32	1 3/16	4 1/4	7/16

305SIPY-套件: SIP16-SIP24(5件)



球底万向浅冲击套筒

mm	6	A	B	D	E
10	IPLM10B	15.6	23.8	73.7	9.7
11	IPLM11B	17.8	23.8	73.7	9.7
12	IPLM12B	18.9	23.8	73.7	9.7
13	IPLM13B	19.7	23.8	73.7	8.6
14	IPLM14B	21.3	23.8	73.7	8.6
15	IPLM15B	22.6	23.8	73.7	8.6
16	IPLM16B	24.1	30.2	77.8	10.4
17	IPLM17B	25.6	30.2	77.7	10.4
18	IPLM18B	26.7	30.2	77.7	10.4
19	IPLM19B	28.3	30.2	77.7	11.2
21	IPLM21B	31.5	30.2	77.7	12.7
22	IPLM22B	33.1	30.2	77.8	14.2
24	IPLM24B	34.8	30.2	81.0	15.0

310IPLMY-套件: 包括IPLM10B-IPLM19B(10件)(10至19mm), 配A270滑轨与套筒夹



305SIPY



警告:

- 不要将机用工具及配件, 配合冲击工具使用
- 在使用球行方向工具时, 不要去握接头处



冲击套筒/特别套筒

快速容易地卸去已损坏和打圆的螺钉及螺帽。简单地将套筒放置在紧固件上。使用1/2英寸方头驱动把或是冲击枪来转动。套在紧固件上应用超强的扭力抓紧它。无需在紧固件上方敲击套筒。作用的紧固件直径最大到1英寸。应用于油盘排油塞，喷口总管螺母，柱头螺栓，管头，及被腐蚀母螺帽。

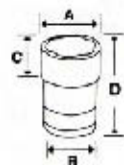

内螺旋浅套筒

尺寸	型号	A	B	C	D
3/4	TTWY241A	1 1/32	1	1	1 5/8
13/16	TTWY261A	1 1/8	1	1	1 5/8
7/8	TTWY281A	1 3/16	1 1/16	1	1 5/8
15/16	TTWY301A	1 1/4	1 3/16	1	1 5/8
1	TTWY321A	1 5/16	1 1/4	1	1 5/8

305TTWYA-内螺旋浅套筒套件：包括TTWY241A-TTWY321A(共5件)(3/4"到1")
配滑轨与套筒夹



内螺旋浅套筒

尺寸	型号	A	B	C	D
3/4	STTWY241	1 1/16	1 1/16	2 7/16	3 1/4
3/4	STTWY261	1 1/8	1 1/8	2 7/16	3 1/4
3/4	STTWY281	1 3/16	1 3/16	2 9/16	3 1/4
3/4	STTWY301	1 5/16	1 5/16	2 9/16	3 1/4
3/4	STTWY321	1 11/32	1 11/32	2 9/16	3 1/4

305STTWY-内螺旋浅套筒套件：包括STTWY241-STTWY321(共5件)(3/4"到1")
配滑轨与套筒夹

冲击附件

PIT3120EB

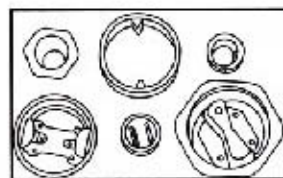

鼓形插销套筒

A172A 一个套筒能卸除所有的放入鼓形插销及成大或小的帽盖。弹簧加载于内部扳手柄的小插销，当卸除大的插销时自动凹下去。工作时使用1/2"方头棘轮扳手或是冲击扳手

PIT160 冲击驱动把

此1/2"方头的工具需要用锤子的打击来产生凸轮的运动。

PIT3120EB 冲击驱动把套装

PIT160冲击驱动把，加上套筒及套筒螺丝刀头(12件)，配KRA142金属工具箱

PIT160	冲击驱动把	SA20E	5/8" 6角套筒螺丝刀头
SA10E	5/16" 6角套筒螺丝刀头	SP32E	#3 十字套筒螺丝刀头
SA12E	3/8" 6角套筒螺丝刀头	SP42E	#3 十字套筒螺丝刀头
SA14E	7/16" 6角套筒螺丝刀头	SW28E	7/16" x .050" 一字套筒螺丝刀头
SA16E	1/2" 6角套筒螺丝刀头	SW32E	1/2" x .075" 一字套筒螺丝刀头
SA18E	9/16" 6角套筒螺丝刀头	KRA142	金属工具箱

锁定式延长杆

理想地用在传动壳体螺钉及传动轴和悬吊系统。把颈部向后拉可以快速简便地装卸套筒。带凸边的快卸颈部可以简单地用单手操控。

型号	A	B
IMXL32	5/8	3 1/2
IMXL52	5/8	5
IMXL102	5/8	10

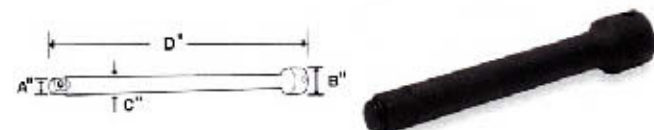

延长杆转接头(轮胎专用工具)

型号	A	B	C	D
IMXA42	3/8	1/2	1/2	4

钩环销套筒

设计尺寸比钩环略大，专用于收割机及半卡车上钩环销。

SPS10 41/64" x 1 3/32", 1 3/4"长
SPS11 21/32" x 1 17/32", 1 3/4"长



延长杆转接头(轮胎专用工具)

型号	A	B
IMX32B	5/8	3
IMX52	21/32	5 3/32
IMX112	21/32	11 1/4

万向接头

型号	A	B
IP80C	1 3/16	2 1/2



3/4" 方头

12角常用工具套件



43HDB-12角常用工具套件(金属工具箱)

35件工具包括:

426LDH	12角浅套筒套件	H-51H1(W)	棘轮头附带
L32	33" 延长杆		19 1/4" 手柄
L62	8" 延长杆	L82A	万向接头
L122	16" 延长杆	L112E	变向接头
L52B	滑动接头	L672B	棘轮转头
		KRA226A	金属工具箱

414AHD-12角常用工具套件(塑料工具箱)

12件工具包括:

12浅套筒			还包括:	
LDH342	1 1/16"	LDH462	1 7/16"	L62 8" 延长杆
LDH362	1 1/8"	LDH482	1 1/2"	L122 16" 延长杆
LDH402	1 1/4"	LDH522	1 5/8"	H-51H1(W) 棘轮头附带
LDH422A	1 5/16"	LDH562	1 3/4"	19 1/4" 手柄
LDH442	1 3/8"	LDH602	1 7/8"	L112E 变向棘轮头



WSH-22TB(W)

12角套筒驱动把套件, 22件套

定货号	尺寸规格
H-41AA(W)	可翻转头
H-51B(W)	可正反转棘轮扳手, 20"
H-104(W)	延长杆, 3"
H-110(W)	延长杆, 8"
H-115(W)	延长杆, 16"
H-104A(W)	万向接头
H-1228(W)	12角标准套筒, 7/8"
H-1230(W)	12角标准套筒, 15/16"
H-1232(W)	12角标准套筒, 1"
H-1234(W)	12角标准套筒, 1 1/16"
H-1236(W)	12角标准套筒, 1 1/8"
H-1240(W)	12角标准套筒, 1 1/4"
H-1242(W)	12角标准套筒, 1 5/16"
H-1244(W)	12角标准套筒, 1 3/8"
H-1246(W)	12角标准套筒, 1 7/16"
H-1248(W)	12角标准套筒, 1 1/2"
H-1252(W)	12角标准套筒, 1 5/8"
H-1254(W)	12角标准套筒, 1 11/16"
H-1256(W)	12角标准套筒, 1 3/4"
H-1258(W)	12角标准套筒, 1 13/16"
H-1260(W)	12角标准套筒, 1 7/8"
H-1264(W)	12角标准套筒, 2"

金属工具箱: TB-11

棘轮头手柄



13/16" 手柄开口度较小



镀铬可正反转棘轮头

定货号	长度	Lbs.	Kgs.
H-51AA(W)	6	3.13	1.42

满足标准: ANSI B107.10M

- 棘轮齿数为24齿
- 小操纵杆可即刻调节正反转
- 小圆珠及弹簧保持套筒稳定配合
- 手柄, 应使用H-A1(W)手柄
- 可承受极高的扭力作用
- 维修附件定货号为H-52EHRK(W)

手柄

定货号	长度	Lbs.	Kgs.
H-A1(W)	19 1/4	3.77	1.712

- 配合可正反转棘轮头H-51AA(W)使用
- 带凸面的手柄起到防滑的作用

(W) WILLIAMS® 为Snap-on® 旗下品牌之一, 专业生产大尺寸工具。



警告



- 定期检查、清洁和用轻质油润滑棘轮机构
- 使用工具箱内的全套部件, 不要个别替换零件

套筒及棘轮类附件 3/4" 方头

棘轮转接头

				A	B	C		
L672B	GL672B	44	8°	3/4	2 1/2	3 15/16	RKR881B	RKR880A

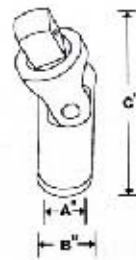

接头

		A	B	C
L112E	GL112E	13/16	1 9/16	3 43/64
L8112	-	15/16	1 9/16	3 11/16



T形可滑动手柄

专门面对重型工作。可当作一个T形手柄或是一把带偏移角扳手使用。弹簧及防滑圆珠可使头部固定。

	C		C			A	B
H-20A(W)	19 1/4	HB-20A(W)	20 7/16	L52B	GL52B	1 1/2	2 5/16

ASME/ANSI B107.10M-1996

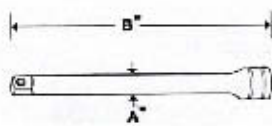
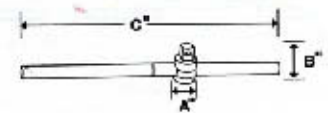

带锁定钮延长杆

A			B
3	L32	GL32	15/16
5	L42	GL42	15/16
8	L62	GL62	15/16
16	L122	GL122	15/16

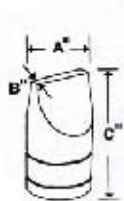

扁头套筒螺丝刀头

	B × A	A	B
GLD138	13/64 × 1 3/8	1 3/8	2 3/16
GLD139	1/4 × 1 11/16	1 11/16	2 3/16

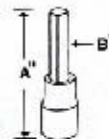

内六角套筒螺丝刀头

	A	B
9/16 LAW118E	3 9/16	SA18E2
5/8 LAW120E	3 3/4	LAWA20E2
3/4 LAW124E	4 3/8	LAW124E2

万向接头

		A	B
L82A	GL82A	19 9/16	3 7/8

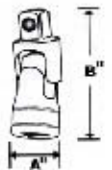

转接头

	A	B	C	D
GLA12B	1/2	3/4	1 1/8	1 7/8
GLA62A	3/4	1/2	-	3
GLA72A	3/4	1	1 7/16	2 5/8
GLA124A	1	3/4	1 13/16	2 3/4

ASME/ANSI B107.10M-1996

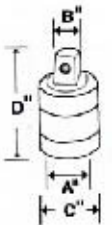

(W) WILLIAMS® 为 Snap-on® 旗下品牌之一，专业生产大尺寸工具。

3/4" 方头 FLANK DRIVE® 套筒

所有的3/4" 方头的镀铬套筒都有LOXOCKET附件。
套筒有独特的按钮来从标准可锁定方头上脱落。

浅套筒

	12	A	B	C	D	E
3/4	LDH242	1 1/8	1 7/16	1 1/4	2	15/32
13/16	LDH262	1 7/32	1 7/16	1 1/4	2	11/16
7/8	LDH282	1 5/16	1 7/16	1 1/4	2	11/16
15/16	LDH302	1 3/8	1 7/16	1 1/4	2	23/32
31/32	LDH312	1 13/32	1 7/16	1 1/4	2	23/32
1	LDH322	1 15/32	1 1/2	1 5/16	2 1/16	3/4
1 1/16	LDH342	1 5/16	1 1/2	1 3/8(1 5/16)	2 1/8	3/4
1 1/8	LDH362	1 5/8	1 1/2	1 7/16(1 3/8)	2 3/16	13/16
1 3/16	LDH382	1 11/16	1 1/2	1 1/2(1 7/16)	2 1/4	7/8
1 1/4	LDH402	1 3/4	1 1/2	1 1/2(1 7/16)	2 1/4	15/16(7/8)
1 5/16	LDH422A	1 7/8	1 5/8	1 9/16(1 3/8)	2 15/16	7/8
1 3/8	LDH442	1 15/16	1 5/8	1 9/16(1 3/8)	2 15/16	7/8
1 7/16	LDH462	2	1 5/8	1 5/8(1 7/16)	2 3/8	15/16
1 1/2	LDH482	2 1/8	1 5/8	1 11/16(1 9/16)	2 1/2	1 1/16(1)
1 9/16	LDH502	2 3/16	1 3/4	1 7/8(1 11/16)	2 5/8	1 5/32
1 5/8	LDH522	2 1/4	1 3/4	1 7/8(1 11/16)	2 5/8	1 5/32
1 11/16	LDH542	2 3/8	1 3/4	2	2 3/4	1 3/16
1 3/4	LDH562	2 7/16	1 3/4	2	2 3/4	1 3/16
1 13/16	LDH582	2 1/2	1 3/4	2 1/8(1 15/16)	2 7/8	1 1/4
1 7/8	LDH602	2 9/16	1 3/4	2 1/4(2 1/16)	3	1 5/16
2	LDH642	2 3/4	1 3/4	2 3/8(2 3/16)	3 1/8	1 3/8
2 1/16	LDH662	2 15/16	1 3/4	2 3/8	3 1/8	1 3/8
2 1/8	LDH682	2 15/16	1 3/4	2 1/2(2 5/16)	3 1/4	1 7/16
2 3/16	LDH702	2 15/16	1 3/4	2 1/2(2 5/16)	3 1/4	1 1/2
2 1/4	LDH722	3 1/8	1 3/4	2 5/8(2 7/16)	3 3/8	1 1/2
2 3/8	LDH762	3 1/4	1 3/4	2 5/8(2 7/16)	3 5/8	1 3/4



镀铬套件:

426LDH-12角浅套筒套件: LDH242至LDH762(26件)

426LDHY-12角浅套筒套件: LDH242至LDH762(26件) (3/4"至2 3/8"), 配2个A268滑轨和套筒夹上

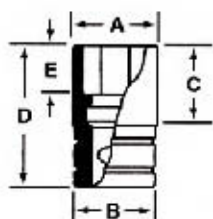

413LDHMY



浅套筒

mm	12	A	B	C	D	E
19	HM-1219(W)	31.1	34.6	30.2	50.8	17.1
22	LDHM222	31.1	34.6	30.2	50.8	17.1
24	LDHM242	33.4	34.6	31.8	50.8	17.9
27	LDHM272	37.3	34.6	31.8	54.0	19.9
30	LDHM302	41.0	39.8	34.0	57.2	21.8
32	HM-1232(W)	44.2	43.0	33.5	57.2	21.8
35	HM-1235(W)	49.3	41.2	35.1	58.7	22.4
36	LDHM362	49.3	41.2	35.1	58.7	22.1
38	HM-1238(W)	52.3	44.2	39.9	63.5	24.9
41	HM-1241(W)	55.1	44.5	42.9	66.5	26.7
46	HM-1246(W)	61.5	44.5	49.5	73.2	29.7
50	LDHM502	66.5	44.5	47.8	76.2	33.1
54	HM-1254(W)	76.7	44.5	55.6	82.6	36.6
55	LDHM552	73.2	44.5	52.8	82.6	36.8
60	HM-1260(W)	80.9	50.8	68.2	92.1	42.1



警告



- 请勿将镀铬或经工业处理的手动工具应用于动力工具
- 定期检查、清洁和用轻质油润滑棘轮机构
- 使用工具箱内的全套部件。不要个别替换零件

(W) WILLIAMS® 为Snap-on® 旗下品牌之一, 专业生产大尺寸工具。

FLANK DRIVE® 套筒

3/4" 方头

深套筒

定货号	尺寸	A	类型	B	C	D	E	螺帽直径	F	Lbs.	Kgs.
HD-628(W)	7/8	3 1/2	I	1 7/16	1 5/16	3/4	2 1/2	11/16	2 5/16	.82	.37
HD630(W)	15/16	3 1/2	I	1 7/16	1 3/8	7/8	2 1/2	11/16	2 5/16	.82	.37
HD-632(W)	1	3 1/2	I	1 1/2	1 7/16	1	2 15/32	11/16	2 5/16	.80	.36
HD-634(W)	1 1/16	3 1/2	II	1 1/2	1 9/16	1	2 1/2	3/4	2 7/32	1.12	.51
HD-636(W)	1 1/8	3 1/2	II	1 1/2	1 5/8	1	2 1/2	25/32	2 7/32	1.18	.54
HD-640(W)	1 1/4	3 1/2	II	1 1/2	1 3/4	1	2 1/2	7/8	2 3/16	1.32	.60
HD-642(W)	1 5/16	3 1/2	II	1 5/8	1 7/8	1	2 1/2	1 5/16	2 3/16	1.44	.65
HD-644(W)	1 3/8	3 1/2	II	1 5/8	1 15/16	1	2 9/16	1 3/8	2 3/16	1.68	.76
HD-646(W)	1 7/16	3 1/2	II	1 5/8	2	1	2 9/16	1 7/16	2 1/8	1.92	.87
HD-648(W)	1 1/2	3 1/2	II	1 5/8	2 1/16	1 1/4	2 9/16	1 1/2	2 1/8	2.04	.93
HD-652(W)	1 5/8	3 1/2	II	1 3/4	2 1/4	2 9/16	2 9/16	1 5/8	2 1/8	2.30	1.04

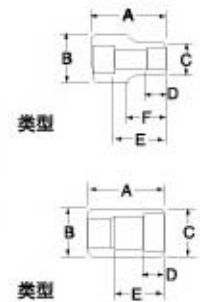

FLANK DRIVE® 冲击套筒

浅套筒



尺寸	6角	A	B	C	D	E
9/16	IM182A	1	1 5/8	1	1 3/4	7/16
5/8	IM202A	1 3/32	1 5/8	1	1 3/4	1/2
11/16	IM222A	1 5/32	1 5/8	1	1 3/4	9/16
3/4	IM242A	1 1/4	1 5/8	1	1 3/4	9/16
13/16	IM262A	1 3/8	1 5/8	1 1/8	1 7/8	5/8
7/8	IM282A	1 1/2	1 5/8	1 1/8	1 7/8	5/8
15/16	IM302A	1 9/16	1 5/8	1 1/8	1 7/8	3/4
1	IM322A	1 5/8	1 5/8	1 1/4	2	3/4
1 1/16	IM342A	1 11/16	1 5/8	1 1/4	2	3/4
1 1/8	IM362	1 7/8	1 5/8	1 3/8	2 1/8	3/4
1 3/16	IM382	1 7/8	1 5/8	1 5/16	2 1/8	3/4
1 1/4	IM402	2	1 3/4	1 3/8	2 1/8	13/16
1 5/16	IM422	2 1/8	1 3/4	1 1/2	2 1/4	7/8
1 3/8	IM442	2 1/8	1 3/4	1 1/2	2 1/4	7/8
1 7/16	IM462	2 1/4	1 3/4	1 1/2	2 1/4	7/8
1 1/2	I6-648(W)	2 1/4	1 3/4	1 1/2	2 1/4	15/16
1 9/16	6-650(W)	2 7/16	1 3/4	1 9/16	2 3/8	15/16
1 5/8	6-652(W)	2 7/16	1 3/4	1 5/8	2 3/8	7/8
1 11/16	6-654(W)	2 1/2	1 3/4	1 13/16	2 9/16	1
1 3/4	6-656(W)	2 1/2	1 3/4	1 13/16	2 9/16	1
1 13/16	6-658(W)	2 5/8	1 3/4	1 5/8	2 5/8	1 1/4
1 7/8	6-660(W)	2 5/8	1 3/4	1 3/4	2 3/4	1 1/8
2	6-664(W)	2 5/8	1 3/4	1 15/16	2 7/8	1 1/8
2 1/16	6-666(W)	3	1 3/4	1 7/8	2 7/8	1 3/16
2 3/16	6-670(W)	3 1/4	1 3/4	2 3/16	3 3/16	1 5/16
2 1/4	6-672(W)	3 1/4	1 3/4	2 3/16	3 3/16	1 3/8
2 3/8	6-676(W)	3 1/2	1 3/4	2 3/8	3 1/2	1 7/16

6角套件:

413IMYA -6角浅套筒套件: IM182A至IM422(13件)(9/16"至1 1/16"), 配2个A267滑轨和套筒夹

浅套筒

mm	6角	A	B	C	D	E
17	IMM172A	29.4	41.3	25.4	44.5	14.3
19	IMM192A	31.8	41.1	19.1	44.5	14.2
20	IMM202A	32.5	41.3	25.4	44.5	14.3
22	IMM222A	36.5	41.3	28.6	47.6	15.8
24	IMM242A	39.7	41.3	28.6	47.6	15.8
27	IMM272A	42.9	41.3	27.2	50.8	17.5
30	IMM302	47.0	41.3	24.9	53.3	19.1
31	IMM312	49.2	41.3	30.2	53.8	19.1
32	IMM322	50.8	44.5	30.2	53.8	20.6
34	IMM342	50.8	44.5	30.2	53.8	22.4
35	IMM352	54.0	44.5	33.5	57.2	22.4
36	IMM362	54.0	44.5	31.8	57.2	22.4
38	IMM382	57.2	44.5	33.5	57.2	23.9
40	IMM402	60.3	44.5	41.3	66.5	28.4
46	IMM462	65.9	44.5	42.9	66.5	29.0

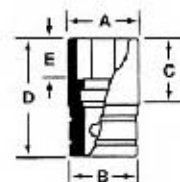

(W) WILLIAMS® 为Snap-on® 旗下品牌之一, 专业生产大尺寸工具。



深套筒

			A	B	C	D	E
3/4	SIM242		1 1/4	1 5/8	2	3	9/16
13/16	SIM262		1 3/8	1 5/8	2	3	5/8
7/8	SIM282		1 1/2	1 5/8	2	3	5/8
15/16	SIM302		1 5/8	1 5/8	2	3	5/8
1	SIM322		1 5/8	1 5/8	2	3	11/16
1 1/16	SIM342		1 3/4	1 5/8	2	3	11/16
1 1/8	SIM362		1 3/4	1 5/8	2	3	3/4
1 3/16	SIM382		2	1 3/4	2 1/4	3 1/4	3/4
1 1/4	SIM402		2	1 3/4	2 1/4	3 1/4	7/8
1 5/16	SIM422		2 1/8	1 3/4	2 9/16	3 1/4	7/8
1 3/8	SIM442		2 1/8	1 3/4	2 1/4	3 1/4	7/8
1 7/16	SIM462		2 3/16	1 3/4	2 1/2	3 1/2	7/8
1 1/2	16-648(W)		2 1/4	1 3/4	2 1/2	3 1/2	15/16
1 9/16	16-650(W)		2 5/16	1 3/4	2 1/2	3 1/2	15/16
1 5/8	16-652(W)		2 7/16	1 3/4	2 1/2	3 1/2	15/16
1 11/16	16-654(W)		2 1/2	1 3/4	2 1/2	3 1/2	1
1 3/4	16-656(W)		2 1/2	1 3/4	2 1/2	3 1/2	1
1 13/16	16-658(W)		2 5/8	1 3/4	2 3/4	3 3/4	1 1/16
1 7/8	16-660(W)		2 11/16	1 3/4	2 3/4	3 3/4	1 1/8
2	16-664(W)		2 13/16	1 3/4	2 3/4	3 3/4	1 1/8



警告



• 请勿将镀铬或经工业处理的手动工具用于动力工具



深套筒

订货号	尺寸	类型	A	B	C	D	E	螺帽直径	F	Lbs.	Kgs.
16M-619(W) 19	I	3	1 5/8	1 1/4	9/16	2 1/32	9/16	3/4	1.20	.54	
16M-624(W) 24	II	3	1 5/8	1 5/8	19/32	2	11/16	-	1.15	.52	
16M-627(W) 27	II	3	1 5/8	1 11/16	11/16	2 1/32	3/4	2 5/16	1.25	.57	
16M-630(W) 30	II	3 3/16	1 3/4	1 15/16	3/4	2 7/32	1 3/16	2 1/2	1.70	.77	
16M-632(W) 32	II	3 1/4	1 3/4	1 15/16	7/8	2 9/32	1 1/4	2 9/16	1.50	.68	
16M-633(W) 33	II	3 1/4	1 3/4	2	7/8	2 9/32	1 9/32	2 9/16	1.60	.73	
16M-635(W) 35	II	3 1/4	1 3/4	2 1/8	7/8	2 9/32	1 3/8	2 9/16	1.75	.79	
16M-636(W) 36	II	3 1/2	1 3/4	2 1/8	7/8	2 17/32	1 13/32	2 13/16	1.80	.82	
16M-638(W) 38	II	3 1/2	1 3/4	2 1/4	15/16	2 17/32	1 1/2	2 13/16	1.95	.88	

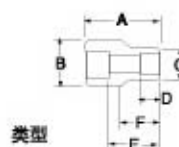

冲击附件

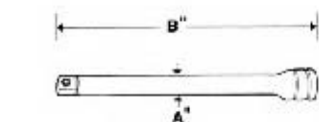

延长杆

	A	B
6-107(W)	1	7
6-110(W)	1	9 3/4
IM92A	1	10
6-113(W)	1	12 3/4



可旋转球底万向接头

	A	B
IP82	1 3/4	3 5/32

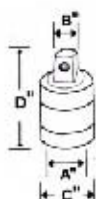

转接头

	A	B	C	D
IM72	3/4	1" 带销孔	1 5/8	2 9/16
IM124B	1	3/4" 带销孔	2 3/8	2 13/16



配合使用在本页及前两页的套筒上

订货号	方头尺寸	规格	配合使用
IM182R	3/4	复合橡胶锁定环	所有3/4"方头套筒及配件
IM182P	3/4	钢制锁定销	所有3/4"方头套筒及配件
IM182PP	3/4	加固塑料锁定销	所有3/4"方头套筒及配件
IMR2	3/4	套筒固定器	所有3/4"方头套筒及配件

使用以下配件配合IM124B转接头

IM243R	1	锁定环
IM243P	1	钢制锁定销
IM243PP	1	加固塑料锁定销

1" 方头

棘轮头及手柄



棘轮头

				A	B	C	
L873	GL873	30	12°	1 1/2	3 1/8	7 7/8	RKRQC5



手柄
带凸面的手把

		A	C
L53HB	GL53HB	1 1/8	29



套筒及棘轮附件

L853HA1	GL853HA1	1 3/8	36
---------	----------	-------	----

头部与手柄组合			
定货号	规格	配合的手柄	可选手柄 延长杆
L873	棘轮头	L53HB	L853HA1
GL873	棘轮头	GL53HB	GL853HA1
L113H	变向手柄	L53HB	-
L53A	可滑动T形手柄	L53HB	-

带锁定钮的延长杆

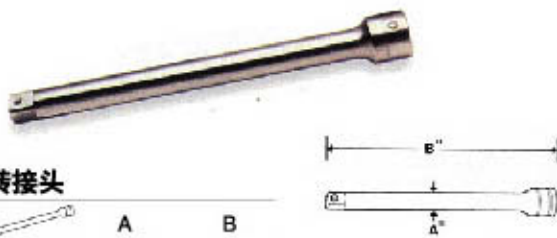

转接头

	A	B
L63	1 1/4	8
L123	1 1/4	16

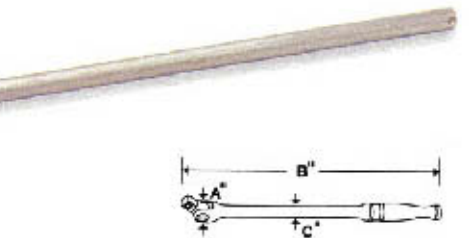
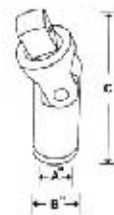

变向手柄

整个工具	仅为头部	
B	C	B
L113H 32 5/32	L113 4 29/32	L113 2 1/8

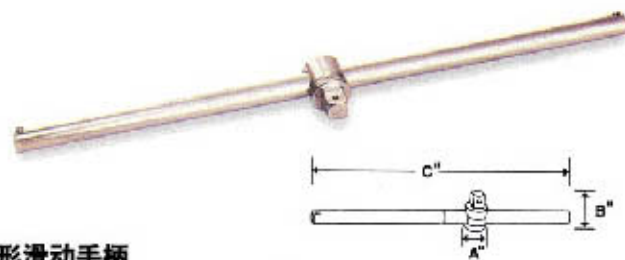

T形滑动手柄

整个工具	仅为 滑动头	手柄 定货号
C	A	
L53 29	L53A 2	L53HB

	A	B	D
GLA72A	3/4	1	2 5/8
GLA124A	1	3/4	2 3/4

ASME/ANSI B107.10M-1996



警告

- 请勿将镀铬或轻工业处理的手动工具应用在动力工具
- 定期检查、清洁和用清质油润滑棘轮机构
- 使用工具箱内的全套部件，不要个别替换零件

1"方头 套筒及冲击套筒

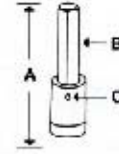
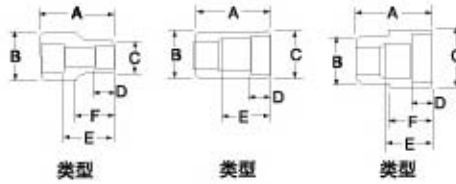

浅套筒

定货号	尺寸	类型A	B	C	D	E	螺帽直径	F	Lbs.	Kgs.
7-624(W)	3/4	2 1/8	2 1/8	1 7/16	11/16	15/16	3/4	7/8	1.18	.54
7-626(W)	13/16	2 1/8	2 1/8	1 7/16	11/16	15/16	3/4	7/8	1.08	.49
7-628(W)	7/8	2 1/8	2 1/8	1 1/2	11/16	15/16	3/4	7/8	1.17	.53
7-630(W)	15/16	2 1/8	2 1/8	1 19/32	5/8	15/16	3/4	7/8	1.20	.54
7-632(W)	1	2 1/4	2 1/8	1 11/16	11/16	1 1/16	3/4	7/8	1.33	.60
7-634(W)	1 1/16	2 1/4	2 1/8	1 3/4	11/16	1 1/16	3/4	7/8	1.35	.61
7-636(W)	1 1/8	2 1/4	2 1/8	1 7/8	11/16	1 1/16	13/16	7/8	1.39	.63
7-638(W)	1 3/16	2 1/4	2 1/8	1 7/8	11/16	1 1/16	13/16	7/8	1.50	.68
7-640(W)	1 1/4	2 3/8	2 1/8	2	3/4	1 3/16	15/16	7/8	1.55	.70
7-642(W)	1 5/8	2 1/2	2 1/8	2 1/16	7/8	1 5/16	1	1	1.52	.69
7-644(W)	1 3/8	2 1/2	2 1/8	2 1/8	7/8	1 5/16	1 3/8	-	1.50	.68
7-646(W)	1 7/16	2 1/2	2 1/4	2 1/4	29/32	1 5/16	1 7/16	-	1.68	.76
7-648(W)	1 1/2	2 5/8	2 1/4	2 11/32	15/16	1 5/32	1 1/2	1 5/8	1.90	.86
7-650(W)	1 9/16	2 5/8	2 1/4	2 3/8	15/16	1 7/16	1 9/16	1 5/8	1.86	.84
7-652(W)	1 5/8	2 3/4	2 1/4	2 3/8	1 1/16	1 5/8	1 19/32	1 3/4	1.85	.84
7-654(W)	1 11/16	2 3/4	2 3/8	2 19/32	1 1/16	1 31/32	1 7/32	1 3/4	2.14	.97
7-656(W)	1 3/4	2 7/8	2 3/8	2 5/8	1 5/32	1 31/32	1 7/16	1 7/8	2.47	1.12
7-658(W)	1 13/16	2 15/16	2 3/8	2 3/4	1 3/16	1 31/32	1 13/16	1 15/16	2.65	1.20
7-660(W)	1 7/8	2 15/16	2 3/8	2 3/4	1 3/16	2 5/32	1 7/16	1 15/16	2.63	1.19
7-662(W)	1 15/16	2 15/16	2 3/8	2 3/4	1 3/16	2 5/32	1 3/8	1 15/16	2.56	1.16
7-664(W)	2	3 1/8	2 3/8	3	1 9/32	2 5/32	1 13/32	2 1/8	3.25	1.47
7-666(W)	2 1/16	3 1/8	2 3/8	3	1 9/32	2 11/32	1 1/2	2 1/8	3.13	1.42
7-668(W)	2 1/8	3 1/4	2 3/8	3 1/8	1 9/32	2 11/32	1 5/8	2 1/4	3.50	1.59
7-670(W)	2 3/16	3 5/16	2 3/8	3 1/4	1 7/16	2 15/32	1 5/8	2 5/16	3.86	1.75
7-672(W)	2 1/4	3 5/16	2 3/8	3 1/4	1 7/16	2 15/32	1 5/8	2 5/16	3.75	1.70
7-674(W)	2 5/16	3 1/2	2 3/8	3 3/8	1 1/2	2 5/16	1 3/4	2 1/2	4.21	1.91
7-676(W)	2 3/8	3 1/2	2 3/8	3 1/2	1 1/2	2 15/32	1 3/4	2 1/2	4.53	2.05
7-678(W)	2 7/16	3 1/2	2 3/8	3 1/2	1 1/2	2 21/32	1 3/4	2 1/2	4.42	2.00
7-680(W)	2 1/2	3 5/8	2 3/8	3 1/2	1 5/8	2 11/16	2 1/2	2 5/8	4.36	1.98
7-682(W)	2 9/16	3 5/8	2 3/8	3 5/8	1 5/8	2 11/16	2 9/16	2 5/8	4.75	2.15
7-684(W)	2 5/8	3 5/8	2 3/8	3 3/4	1 5/8	2 11/16	1 7/8	2 5/8	4.98	2.26
7-686(W)	2 11/16	3 7/8	2 3/8	3 3/4	1 13/16	3 5/16	2	2 7/8	5.24	2.38
7-688(W)	2 3/4	3 7/8	2 3/8	3 3/4	1 13/16	3 5/16	2 3/4	2 7/8	5.00	2.27
7-690(W)	2 13/16	4	2 3/8	4	1 13/16	3 1/32	2	3	6.31	2.86
7-692(W)	2 7/8	4	2 3/8	4	1 13/16	3 5/16	2	3	5.97	2.71
7-694(W)	2 15/16	4 3/16	2 3/8	4 1/8	2 1/32	3 11/32	2 15/16	3 1/8	6.50	2.95
7-696(W)	3	4 3/8	2 3/8	4 1/4	2 1/16	3 11/32	2 3/8	3 3/8	7.40	3.36
7-6100(W)	3 1/8	4 3/8	2 3/8	4 1/4	2 1/16	3 13/32	2 3/8	3 3/8	7.30	3.31
7-6104(W)	3 1/4	4 3/8	2 3/8	4 1/2	2 1/16	3 12/64	2 3/8	3 3/8	7.78	3.53
7-6108(W)	3 3/8	4 23/32	2 3/8	4 5/8	2 1/4	3 9/16	2 1/2	2 39/64	9.45	4.29
7-6112(W)	3 1/2	4 3/4	2 3/8	4 3/4	2 1/4	3 25/32	2 1/2	2 5/8	9.65	4.38
7-6116(W)	3 5/8	4 3/4	2 3/8	5	2 5/16	3 25/32	2 5/8	2 19/32	10.41	4.72
7-6118(W)	3 11/16	4 3/4	2 3/8	5 5/16	2 7/16	3 25/32	2 3/4	2 15/16	12.69	5.76
7-6120(W)	3 3/4	5 1/16	2 3/8	5 1/8	2 3/8	3 19/32	2 5/8	3 5/32	12.83	5.82
7-6122(W)	3 13/16	5 3/16	2 3/8	5 3/8	2 17/32	3 25/32	2 5/8	3 23/64	14.88	6.75
7-6124(W)	3 7/8	5 1/4	2 3/8	5 1/4	2 9/16	3 55/64	2 3/4	3 1/8	12.57	5.70
7-6126(W)	3 15/16	5 5/16	2 3/8	5 11/32	2 9/16	3 25/32	3	3 3/16	13.93	6.32
7-6128(W)	4	5 3/8	2 3/8	5 1/2	2 9/16	3 25/32	2 7/8	3 15/64	14.55	6.60
7-6130(W)	4 1/16	5 3/8	2 3/8	5 1/2	2 15/32	3 25/32	3	3 33/64	15.30	6.94
7-6132(W)	4 1/8	5 3/8	2 3/8	5 9/16	2 9/16	3 25/32	2 7/8	3 7/32	14.30	6.49
7-6134(W)	4 3/16	5 1/2	2 3/8	6	2 33/64	3 25/32	3	3 41/64	16.52	7.49
7-6136(W)	4 1/4	5 1/2	2 3/8	5 3/4	2 5/8	3 1/2	3 1/8	3 5/16	15.63	7.09
7-6138(W)	4 5/16	5 1/2	2 3/8	5 13/16	2 21/32	3 25/32	3 3/8	3 5/16	16.82	7.63
7-6140(W)	4 3/8	5 5/8	2 3/8	5 27/32	2 5/8	3 29/32	3 1/8	3 39/64	18.13	8.22
7-6142(W)	4 7/16	5 5/8	2 3/8	6	2 43/64	3 1/8	3 5/8	3 19/32	19.10	8.66
7-6144(W)	4 1/2	5 5/8	2 3/8	6	2 5/8	3 1/8	3 1/8	3 13/32	17.16	7.78
7-6146(W)	4 9/16	5 5/8	3 1/4	6 1/2	2 3/4	4 5/16	3 3/8	3 17/32	26.09	11.83
7-6148(W)	4 5/8	5 3/4	3 1/4	6 13/32	3 1/16	4 17/32	3 1/8	3 25/32	24.31	11.03
7-6152(W)	4 3/4	5 3/4	3 1/4	6 5/8	2 57/64	3 1/2	3 23/32	25.63	11.63	
7-6156(W)	4 7/8	6	3 1/4	7	3	3 1/2	3 31/32	28.00	12.70	
7-6160(W)	5	6 1/4	3 1/4	7	3	3 1/2	4 7/32	33.20	15.06	
7-6172(W)	5 3/8	6 1/2	3 1/4	7 1/2	3 9/16	4 43/64	4 1/4	35.60	16.50	
7-6184(W)	5 3/4	6 1/2	3 1/4	8 1/4	3 9/16	4	4 9/32	37.50	17.01	

定货号	尺寸	类型A	B	C
7/8	IMA283	5 5/8	IMA283-2	ME2C1
1	IMA323	5 5/8	IMA323-2	ME2C1
1 1/8	IMA363	4 1/4	IMA363-2	ME2C1
1 1/4	IMA403	4 3/8	IMA403-2	ME2C1
1 3/8	IMA443	4 1/2	IMA443-2	ME2C1



浅套筒

定货号	尺寸	类型A	B	C	D	E	螺帽直径	F	Lbs.	Kgs.
X-1234(W)	1 1/8	2 1/4	2	1 5/8	3/4	1 1/16	13/16	1 15/32	1.23	.56
X-1236(W)	1 1/8	2 1/4	2	1 3/4	3/4	1 1/16	13/16	7/8	1.28	.58
X-1240(W)	1 1/4	2 3/8	2	1 7/8	3/4	1 1/8	13/16	7/8	1.26	.57
X-1242(W)	1 5/16	2 1/2	2	2 1/16	13/16	1 9/32	1 5/16	1 9/16	1.46	.66
X-1244(W)	1 3/8	2 1/2	2	1 7/8	7/8	1 11/32	1 25/64	1 9/16	1.40	.64
X-1246(W)	1 7/16	2 5/8	2	2 3/16	1	1 15/32	1 31/64	1 11/16	1.54	.70
X-1248(W)	1 1/2	2 3/4	2	2 1/4	1	1 19/32	1 9/16	1 13/16	1.64	.74
X-1252(W)	1 5/8	2 7/8	2	2 3/8	1 1/8	1 3/4	1 1/16	1 15/16	2.34	1.06
X-1258(W)	1 13/16	3 1/8	2 1/8	2 5/8	1 1/4	1 31/32	1 7/16	2 3/16	2.88	1.31
X-1260(W)	1 7/8	3 1/4	2 1/8	2 3/4	1 7/16	1 15/16	1 7/16	2 5/16	2.47	1.12
X-1264(W)	2	3 3/8	2 1/8	2 15/16	1 1/2	2 1/4	1 7/16	2 7/16	2.08	.94
X-1268(W)	2 1/3	3 1/2	2 1/4	3 1/8	1 1/2	2 11/32	1 7/16	2 9/16	2.36	1.07
X-1270(W)	2 3/16	3 5/8	2 1/4	3 1/8	1 17/32	2 1/4	2 1/4	2 11/16	2.52	1.14
X-1272(W)	2 1/4	3 3/4	2 1/4	3 1/4	1 5/8	2 5/16	2 21/32	2 7/32	2.72	1.23
X-1276(W)	2 3/8	3 7/8	2 1/4	3 3/8	1 5/8	2 3/4	2 23/64	2 1/16	2.78	1.26
X-1280(W)	2 1/2	4 1/8	2 1/4	3 1/2	1 3/4	2 11/16	2 1/2	3 1/16	3.2	1.51
X-1282(W)	2 9/16	4 1/8	2 1/4	3 9/16	2 13/16	2 3/4	2 9/16	3 3/16	3.44	1.56
X-1284(W)	2 5/8	4 1/4	2 1/4	3 5/8	1 7/8	2 3/4	2 39/64	2 35/64	3.30	1.50
X-1288(W)	2 3/4	4 1/2	2 1/4	3 3/4	2	3	2 3/4	3 9/16	3.70	1.68
X-1294(W)	2 15/16	4 27/32	2 1/4	4	2 1/8	3 9/32	2 15/16	2 31/32	4.20	1.91
X-1296(W)	3	4 7/8	2 1/4	4 1/8	2 1/8	3 5/16	3	2 63/64	4.50	2.04
X-12100	3 1/8	4 27/32	2 1/4	4 1/4	2 1/8	3 3/8	3 1/8	3 1/16	5.00	2.27



浅套筒

定货号	尺寸	类型A	B	C	D	E	螺帽直径	F	Lbs.	Kgs.
X-676(W)	2 3/8	3 7/8	2 1/4	3 3/8	1 5/8	2 3/4	2 23/64	2 1/16	3.44	1.56
X-680(W)	2 1/2	4 1/8	2 1/4	3 1/2	1 3/4	2 11/16	2 2/2	2 9/32	3.86	1.75
X-684(W)	2 5/8	4 1/4	2 1/4	3 5/8	1 7/8	2 3/4	2 39/64	2 25/64	3.82	1.73
X-688(W)	2 3/4	4 1/2	2 1/4	3 3/4	2	3	2 3/4	2 5/8	3.94	1.79
X-694(W)	2 15/16	4 55/64	2 3/8	4	2 1/8	3 9/32	2 15/16	2 21/32	5.88	2.67
X-6100(W)	3 1/8	4 31/32	2 3/8	4 1/4	2 1/8	3 3/8	3 1/8	3 1/16	6.50	2.95

1" 方头 FLANK DRIVE® 冲击套筒



类型

浅套筒

定货号	尺寸	类型	A	B	C	D	E	Lbs.	Kgs.
7M-627(W)	27		2 1/4	2 1/8	2 11/16	11/16	1	1.35	.61
7M-630(W)	30		2 1/4	2 1/8	2 11/16	11/16	1 1/16	1.50	.68
7M-632(W)	32		2 3/8	2 1/8	2 11/16	3/4	1 3/16	1.70	.77
7M-635(W)	35		2 1/2	2 1/8	2 1/8	7/8	1 3/16	1.50	.68
7M-638(W)	38		2 5/8	2 3/8	2 3/8	15/16	1 7/16	1.90	.86
7M-641(W)	41		2 3/4	2 3/8	2 3/8	1 1/16	1 5/8	1.85	.84
7M-646(W)	46		2 15/16	2 3/4	2 3/4	1 3/16	1 3/4	2.65	1.20
7M-650(W)	50		3	2 3/4	2 3/4	1 1/4	1 7/8	2.60	1.18
7M-660(W)	60		3 1/2	3 1/2	3 1/2	1 1/2	2 1/8	4.70	2.13
7M-665(W)	65		3 5/8	3 5/8	3 5/8	1 5/8	2 1/8	4.75	2.15
7M-670(W)	70		3 7/8	3 3/4	3 3/4	1 13/16	2 5/8	5.00	2.27
7M-675(W)	75		4 3/16	4 1/8	4 1/8	2 1/16	2 11/16	6.50	2.95



类型

类型



深套筒

定货号	尺寸	类型	A	B	C	D	E	螺帽直径	F	Lbs.	Kgs.
17-632(W)	1		3	2 1/8	1 19/32	3/4	1 3/16	11/16	7/8	1.90	1.90
17-634(W)	1 1/16		3	2 1/8	1 3/4	3/4	1 3/16	3/4	7/8	1.90	1.90
17-636(W)	1 1/8		3	2 1/8	1 13/16	3/4	1 3/16	13/16	7/8	1.91	1.91
17-638(W)	1 3/16		3	2 1/8	1 13/16	3/4	1 3/16	13/16	7/8	1.91	1.91
17-640(W)	1 1/4		3 1/4	2 1/8	2 1/16	7/8	2 1/16	1 7/32	1	1.99	1.99
17-642(W)	1 5/16		3 1/4	2 1/8	2 1/16	7/8	2 1/16	1 1/8	1	1.98	1.98
17-644(W)	1 3/8		3 1/4	2 1/8	2 1/16	7/8	2 1/16	1 3/8	1	1.85	1.85
17-646(W)	1 7/16		3 1/4	2 1/8	2 1/4	29/32	2 3/32	1 13/32	2 1/4	2.10	2.10
17-648(W)	1 1/2		3 1/2	2 1/4	2 3/8	1	2 11/32	1 15/32	2 1/2	2.59	2.59
17-650(W)	1 9/16		3 1/2	2 1/4	2 3/8	1	2 11/32	1 17/32	2 1/2	2.50	2.50
17-652(W)	1 5/8		3 5/8	2 1/4	2 3/8	1	2 1/2	1 19/32	2 5/8	2.65	2.65
17-654(W)	1 11/16		3 5/8	2 3/8	2 1/2	1 1/8	2 7/16	1 21/32	2 5/8	2.81	2.81
17-656(W)	1 3/4		3 7/8	2 3/8	2 3/4	1 1/8	2 11/16	1 7/16	2 7/8	3.59	3.59
17-658(W)	1 13/16		3 7/8	2 3/8	2 3/4	1 3/16	2 11/16	1 7/16	2 7/8	3.59	3.59
17-660(W)	1 7/8		3 7/8	2 3/8	2 3/4	1 3/16	2 11/16	1 7/16	2 7/8	3.49	3.49
17-662(W)	1 15/16		4 1/8	2 3/8	3	1 1/4	2 15/16	1 7/16	3 1/8	4.23	4.23
17-664(W)	2		4 1/8	2 3/8	3	1 5/16	2 15/16	1 7/16	3 1/8	4.06	4.06
17-666(W)	2 1/8		3 7/8	2 3/8	3	1 5/16	2 15/16	1 1/2	3 1/8	3.92	3.92
17-668(W)	2 1/8		4 3/8	2 3/8	3 1/4	1 5/16	3 3/16	1 5/8	3 3/8	4.50	4.50
17-670(W)	2 3/16		4 3/8	2 3/8	3 1/4	1 1/2	3 3/16	1 5/8	3 3/8	4.59	4.59
17-672(W)	2 1/4		4 3/8	2 3/8	3 1/4	1 1/2	3 3/16	1 5/8	3 3/8	4.58	4.58
17-674(W)	2 5/16		4 1/2	2 3/8	3 1/2	1 1/2	3 5/16	1 7/16	3 1/2	5.48	5.48
17-676(W)	2 3/8		4 1/2	2 3/8	3 1/2	1 1/2	3 5/16	2	3 1/2	5.60	5.60
17-678(W)	2 7/16		4 1/2	2 3/8	3 1/2	1 1/2	3 7/32	1 3/4	3 1/2	6.78	6.78
17-680(W)	2 1/2		4 1/2	2 3/8	3 1/2	1 5/8	3	2 1/2	3 1/2	6.60	6.60
17-682(W)	2 9/16		4 7/8	2 3/8	3 5/8	1 5/8	3 1/2	2	3 7/8	6.53	6.53
17-684(W)	2 5/8		4 11/16	2 3/8	3 3/4	1 5/8	3 11/32	2	3 11/16	7.54	7.54
17-686(W)	2 11/16		4 11/16	2 3/8	3 3/4	1 13/16	2 1/2	2	3 11/16	7.54	7.54
17-688(W)	2 3/4		5 1/8	2 3/8	3 3/4	1 3/4	3 5/8	2	4 1/8	6.39	6.39
17-690(W)	2 13/16		5 1/8	2 3/8	4	1 13/16	2 27/32	2	4 1/8	9.93	9.93
17-692(W)	2 7/8		4 7/8	2 3/8	4	1 13/16	3 9/16	2	3 7/8	8.59	8.59
17-694(W)	2 15/16		4 7/8	2 3/8	4 1/8	2 1/32	2 11/16	2	3 7/8	9.36	9.36
17-696(W)	3		5 1/8	2 3/8	4 1/4	2 1/32	3 7/8	2 3/8	4 1/8	10.82	10.82
17-6100(W)	3 1/8		5 1/8	2 3/8	4 3/8	2 1/32	3 1/32	2 3/8	4 1/8	11.86	11.86
17-6104(W)	3 1/4		5 3/8	2 3/8	4 1/2	2 1/32	3 1/32	2 1/2	4 3/8	11.36	11.36
17-6108(W)	3 3/8		5 1/2	2 3/8	4 5/8	2 1/4	3 5/16	2 1/2	4 1/2	12.87	12.87
17-6112(W)	3 1/2		5 1/2	2 3/8	4 3/4	2 1/4	4 3/32	2 1/2	4 1/2	12.60	12.60
17-6116(W)	3 5/8		5 1/2	2 3/8	5	2 5/16	4 3/32	2 5/8	4 1/2	13.80	13.80
17-6118(W)	3 11/16		5 17/32	2 3/8	5 5/16	2 7/16	3 7/8	2 3/4	4 17/32	16.56	16.56
17-6120(W)	3 3/4		5 9/16	2 3/8	5 1/4	2 1/4	3 19/32	2 13/16	4 9/16	15.98	15.98
17-6122(W)	3 13/16		5 31/32	2 3/8	5 3/8	2 17/32	4 11/32	2 5/8	4 31/32	17.11	17.11
17-6124(W)	3 7/8		5 9/16	2 3/8	5 1/4	2 9/16	3 5/8	3	4 9/16	14.99	14.99
17-6126(W)	3 15/16		6 1/16	2 3/8	5 1/2	2 13/32	4 13/32	3	5 1/16	15.80	15.80
17-6128(W)	4		6 1/8	2 3/8	5 1/2	2 17/32	4 3/32	2 7/8	5 1/8	16.49	16.49
17-6130(W)	4 1/16		6 1/8	2 3/8	5 1/2	2 15/32	4 1/2	3	5 5/32	22.31	22.31
17-6132(W)	4 1/8		6 1/8	2 3/8	5 17/32	2 17/32	4 3/32	2 7/8	5 1/8	23.52	23.52
17-6134(W)	4 3/16		6 7/32	2 3/8	6	2 1/2	4 9/16	3	5 7/32	24.78	24.78
17-6136(W)	4 1/4		6 9/32	2 3/8	5 3/4	2 5/8	4 9/16	3 1/8	5 9/32	23.22	23.22
17-6138(W)	4 5/16		6 11/32	2 3/8	5 13/16	2 21/32	4 5/8	3 3/8	5 11/32	25.31	25.31
17-6140(W)	4 3/8		6 13/32	2 3/8	5 27/32	2 5/8	4 9/16	3 1/8	5 13/32	24.71	24.71
17-6142(W)	4 7/16		6 13/32	2 3/8	6	2 21/32	4 9/16	2 5/8	5 13/32	26.81	26.81
17-6144(W)	4 1/2		7	2 3/8	6	2 3/4	5	3 1/8	6	26.83	26.83
17-6146(W)	4 9/16		7 1/8	3 1/4	6 1/2	2 3/4	4 19/32	3 3/8	6 1/8	26.26	26.26
17-6148(W)	4 5/8		7 1/8	3 1/4	6 13/16	2 13/16	4 3/32	3 1/2	6 1/8	29.36	29.36
17-6152(W)	4 3/4		6 3/4	2 3/8	6 5/8	2 29/32	4 29/32	3 1/2	5 3/4	33.36	33.36
17-6156(W)	4 7/8		7 1/4	3 1/4	7	3	5 5/32	3 1/2	6 1/4	30.55	30.55
17-6160(W)	5		7 3/4	3 1/4	7	3	5 21/32	3 1/2	6 3/4	32.99	32.99
17-6172(W)	5 3/8		8	3 1/4	7 1/2	3 9/16	5 25/32	4 21/32	7	36.90	36.90
17-6184(W)	5 3/4		8	3 1/4	8 1/4	3 9/16	6 1/32	4	7	45.80	45.80

1" 方头锁定环及锁定销专门满足工具的使用定货号

方头尺寸	规格	描述	配合使用
IMR3	1" 方栓	套筒固定器	所有方栓方头套筒及配件, 所有1" 方头套筒及配件
IM243R	1"	复合橡胶锁定环 钢制锁定销	1" 方头套筒及配件至1 3/8" (35mm)
IM243P	1"	复合橡胶锁定环	1" 方头套筒及配件至1 3/8" (35mm)
IM243PP	1"	加固塑料锁定销	1" 方头套筒及配件至1 3/8" (35mm)
IM483R	1" 方栓	橡胶锁定销	所有方栓方头套筒及配件, 所有1" 方头套筒及配件尺寸从1 7/16" (35mm)开始
IM483P	1" 方栓	钢制锁定销	所有方栓方头套筒及配件, 所有1" 方头套筒及配件尺寸从1 7/16" (35mm)开始



警告





• 请勿将镀铬或经工业处理的手动工具应用在动力工具

FLANK DRIVE® 冲击套筒 1" 方头



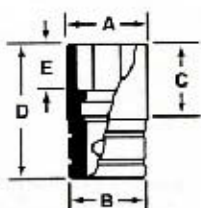

浅双四方套筒

		A	B	C	D	E
1 1/4	IM740	2 3/8	2 3/8	1 1/8	2 3/8	13/16



浅四方套筒

		A	B	C	D	E
3/4	IM724	1 15/16	2 1/8	15/16	2 1/8	5/8
13/16	IM726	1 15/16	2 1/8	15/16	2 1/8	5/8
7/8	IM728	2 1/16	2 1/8	15/16	2 1/8	5/8
15/16	IM730**	2 1/16	2 1/8	15/16	2 1/8	5/8
1	IM732	2 1/8	2 1/8	1 1/16	2 1/4	3/4
1 1/8	IM736	2 1/4	2 1/4	1 1/16	2 1/4	3/4

特殊需求大尺寸可以定做

* 非Flank Drive®

** 应用于Budd车型的车轮

冲击附件

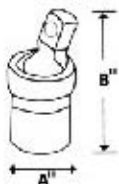

带销孔的可摇动球底万向接头

	A	B
IP83	2 1/2	4 3/16

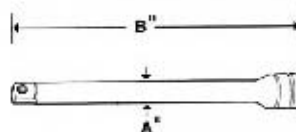

带销孔的延长杆

	A	B
IM133	1	3
IM63B	1 1/8	7 1/8

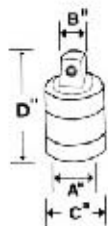

带销孔的转接头





	A	B	C	D
IM72	3/4	1	1 5/8	2 9/16
IM124B	1	3/4	2 3/8	2 13/16



1 1/2" 方头



方头棘轮头及手柄

棘轮扳手

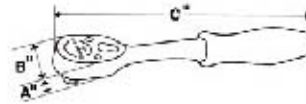
整个工具		仅头部				
	C				CAB	
L78	42	L78Y	16	22 1/2"	9 29/32 × 1 3/4 × 4 1/16	L55-1



带锁定钮可滑动T形手柄

整个工具		仅头部		
	C		A	
L55	36	L55-2	2 1/2	L55-1

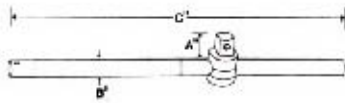

带锁定钮的手柄

	A	C
L55-1	1 3/8	36

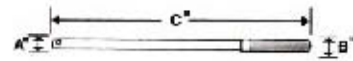

冲击附件

带加固销孔的转接头

	A	B	C	D
IM35	1	1 1/2	2 1/4	3 1/2
IM53	1 1/2	1	3 1/4	4 1/4
IM59	1 1/2	2 1/2	3 1/4	5 1/8
IM95	2 1/2	1 1/2	5	6 3/8



带加固销孔的延长杆

	A	B
8-18(W)	1 1/2	8
8-115(W)	1 1/2	15



带加固销孔的可摇动方向接头

	A	B
8-140B(W)	3 5/8	6 1/16

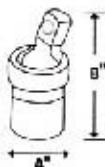

锁定环和锁定销专为1 1/2" 延长杆，转接头，冲击套筒和2 1/2" 冲击套筒专门满足工具的使用

定货号	方头尺寸	规格	配合使用
IM243R	1 1/2"	复合橡胶锁定环	1" 方头套筒及附件至1 3/8" (35mm)
IM243P	1 1/2" 方栓	钢制销	1" 方头套筒及附件至1 3/8" (35mm)
IM243PP	1 1/2"	加固塑料锁定销	1" 方头套筒及附件至1 3/8" (35mm)
IMR3	1 1/2" 方栓	套筒加固器	所有方栓方头套筒及附件，所有1" 方头套筒及附件
IM445R	1 1/2"	复合橡胶锁定销	所有1 1/2" 方头套筒及附件
IM445P	1 1/2"	钢制销	所有1 1/2" 方头套筒及附件
IM729P	1 1/2"	钢制销	所有1 1/2" 方头套筒

警告

- 定期检查、清洁和用轻质油润滑棘轮机构
- 使用工具想内的全套部件，不要个别替换零件

浅套筒

定货号	尺寸	类型A	B	C	D	E	螺帽直径	F	Lbs	Kgs
8-644(W)	1 3/8	3	3 1/4	2 7/8	7/8	1 3/8	1 11/32	1 3/16	4.65	2.11
8-646(W)	1 7/16	3 1/32	3 1/4	2 7/8	57/64	1 25/64	1 7/16	1 7/32	4.24	1.92
8-648(W)	1 1/2	3 3/32	3 1/4	2 7/8	29/32	1 7/16	1 31/64	1 17/64	4.33	1.96
8-652(W)	1 5/8	3 3/16	3 1/4	2 29/32	1 1/32	1 9/16	1 5/8	1 21/64	4.44	2.01
8-654(W)	1 11/16	3 1/4	3 1/4	2 31/32	1 1/16	1 9/16	1 11/16	1 39/64	4.53	2.05
8-656(W)	1 3/4	3 9/32	3 1/4	3 1/32	1 1/32	1 21/32	1 21/32	1 9/16	4.75	2.15
8-658(W)	1 13/16	3 21/64	3 1/4	3 3/32	1 5/32	1 11/16	1 13/16	1 5/8	4.78	2.17
8-660(W)	1 7/8	3 3/8	3 1/4	3 5/32	1 7/32	1 3/4	1 7/8	1 23/32	5.01	2.27
8-664(W)	2	3 7/16	3 1/4	3 1/2	1 9/32	1 13/16	2	1 51/34	5.68	2.58
8-666(W)	2 1/16	3 1/2	3 1/4	3 1/2	1 13/32	1 55/64	2 1/16	1 55/64	5.62	2.55
8-668(W)	2 1/8	3 9/16	3 1/4	3 1/2	1 27/64	1 59/64	2 1/8	1 59/64	5.76	2.61
8-670(W)	2 3/16	3 21/32	3 1/4	3 1/2	1 7/16	2	2 3/16	2 1/64	5.71	2.59
8-672(W)	2 1/4	3 3/4	3 1/4	3 9/16	1 17/32	2 1/8	2 1/4	2 1/8	5.99	2.72
8-676(W)	2 3/8	3 7/8	3 1/4	3 25/32	1 9/16	2 1/4	2 3/8	2 17/64	5.45	2.47
8-678(W)	2 7/16	3 15/16	3 1/4	3 25/32	1 9/16	2 19/64	2 7/16	2 5/16	6.59	2.99
8-680(W)	2 1/2	4	3 1/4	3 7/8	1 19/32	2 3/8	2 31/64	2 1/64	7.15	3.24
8-682(W)	2 9/16	4 1/32	3 1/4	3 29/32	1 5/8	2 13/32	2 9/16	2 3/64	7.10	3.22
8-684(W)	2 5/8	4 3/32	3 1/4	4	1 11/16	2 15/32	2 5/8	2 7/16	7.30	3.31
8-688(W)	2 3/4	4 7/32	3 1/4	4 5/32	1 13/16	2 7/16	2 3/4	2 15/64	7.76	3.52
8-692(W)	2 7/8	4 5/16	3 1/4	4 15/16	1 7/8	2 11/16	2 5/8	2 9/32	8.65	3.92
8-694(W)	2 15/16	4 3/8	3 1/4	4 3/8	1 29/32	2 3/4	2 5/8	2 23/64	8.96	4.06
8-696(W)	3	4 7/16	3 1/4	4 7/16	1 5/16	2 27/32	2 5/8	2 13/32	9.30	4.22
8-698(W)	3 1/16	4 1/2	3 1/4	4 9/16	1 31/32	2 7/8	2 5/8	2 15/32	9.75	4.42
8-6100(W)	3 1/8	4 9/16	3 1/4	4 5/8	2	3	2 5/8	2 1/2	10.29	4.67
8-6104(W)	3 1/4	4 21/32	3 1/4	4 25/32	2 1/8	3	2 5/8	2 19/32	11.00	4.99
8-6108(W)	3 3/8	4 3/4	3 1/4	4 15/16	2 7/32	3 1/8	2 5/8	2 43/64	11.78	5.34
8-6110(W)	3 7/16	4 27/32	3 1/4	5	2 9/32	3 7/32	2 5/8	2 3/4	12.2	5.53
8-6112(W)	3 1/2	4 29/32	3 1/4	5 1/16	2 5/16	3 1/4	2 5/8	2 13/64	14.20	6.44
8-6116(W)	3 5/8	5 1/8	3 1/4	5 1/4	2 13/32	3 7/16	2 5/8	3	13.90	6.30
8-6120(W)	3 3/4	5 1/8	3 1/4	5 3/8	2 15/32	3 1/2	2 5/8	3 1/32	13.60	6.17
8-6122(W)	3 13/16	5 3/16	3 1/4	5 3/8	2 17/32	3 7/8	2 5/8	3 3/32	13.20	5.99
8-6124(W)	3 7/8	5 1/4	3 1/4	5 17/32	2 9/16	3 5/8	2 5/8	3 5/32	14.33	6.50
8-6128(W)	4	5 13/32	3 1/4	5 21/32	2 5/8	3 25/32	2 5/8	3 9/32	17.59	7.98
8-6132(W)	4 1/8	5 9/16	3 1/4	5 13/16	2 3/4	3 59/64	2 5/8	3 7/16	17.09	7.75
8-6136(W)	4 1/4	5 11/16	3 1/4	5 31/32	2 13/16	4 1/16	2 5/8	3 9/16	18.03	8.18
8-6138(W)	4 5/16	5 25/32	3 1/4	6 1/32	2 7/8	4 5/32	2 5/8	3 21/32	17.80	8.07
8-6140(W)	4 3/8	5 27/32	3 1/4	6 3/32	2 29/32	4 7/32	2 5/8	3 21/32	19.36	8.78
8-6144(W)	4 1/2	6	3 1/4	6 1/4	3 1/32	4 3/8	2 5/8	3 15/16	24.13	10.95
8-6148(W)	4 5/8	6 1/16	3 1/4	6 13/16	3 1/16	4 7/16	3 1/2	4 3/32	24.59	11.15
8-6152(W)	4 3/4	6 1/8	3 1/4	6 9/16	3 1/8	4 1/2	2 5/8	4	25.84	11.72
8-6156(W)	4 7/8	6 3/4	3 1/4	7	3 1/8	5 7/64	3 1/2	4 19/32	26.88	12.19
8-6160(W)	5	6 3/4	3 1/4	7 1/8	3 1/16	5 7/64	3 1/2	4 9/16	36.02	16.34
8-6172(W)	5 3/8	7	3 1/4	7 5/16	3 1/4	5 1/8	4	4 29/32	36.08	16.37
8-6184(W)	5 3/4	7	3 1/4	7 5/8	3 1/2	5 1/8	3 3/4	4 7/8	39.62	17.97
8-6196(W)	6 1/2	7 1/4	5	8 1/2	3 11/16	5 3/8	4 1/2	5 1/16	37.50	17.01
8-6208(W)	6 1/8	7 1/2	5	9 1/4	3 1/2	5 5/8	5	5 9/64	72.37	32.83
8-6220(W)	6 7/8	7 1/8	5	9 1/4	3 7/8	6	4 3/4	5 33/64	71.50	32.43
8-6232(W)	7 1/4	8 1/8	5	10	4 1/2	6 1/4	5 1/2	5 49/64	71.77	32.55
8-6244(W)	7 5/8	8 1/4	5	10 3/4	4 13/16	6 3/8	6 1/2	5 57/64	95.82	43.46
8-6256(W)	8	8 3/8	5	11	5 1/16	6 1/2	7	6 1/64	93.00	42.18

1 1/2" 方头 FLANK DRIVE® 冲击套筒

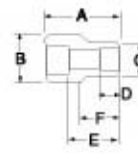

类型

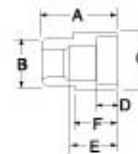

类型

2 1/2" 方头 浅套筒



定货号	尺寸	类型A	B	C	D	E	螺帽直径	F	Lbs	Kgs
9-684(W)	2 5/8	5 1/2	5	5 1/16	2	2 9/16	3 3/8	3 1/4	18.80	8.53
9-684(W)	2 15/16	5 3/4	5	5 1/16	2	2 9/16	3 3/8	3 1/4	20.05	9.09
9-9100(W)	3 1/8	5 3/4	5	5 1/16	2	2 9/16	3 3/8	3 1/4	18.30	8.30
9-6110(W)	3 7/16	5 3/8	5 5/16	5 1/16	2	2 9/16	3 3/8	3 1/4	18.77	8.51
9-6112(W)	3 1/2	5 3/4	5 5/16	5 1/16	2	2 9/16	3 7/16	3 1/4	18.89	9.02
9-6116(W)	3 5/8	5 3/4	5 7/16	5 1/16	2	2 7/8	3 9/16	3 1/4	18.50	8.39
9-6120(W)	3 3/4	6 1/4	5 1/2	5 1/2	2	2 7/8	3 1/2	3 1/4	21.27	9.65
9-6124(W)	3 7/8	6 1/4	5 11/16	5 23/32	2	3 1/4	3 1/2	3 9/16	20.20	9.16
9-6128(W)	4	6 1/4	5 13/16	5 29/32	2	3 1/4	3 1/2	3 9/16	22.15	10.05
9-6132(W)	4 1/8	6 1/4	6	5 29/32	2 5/32	3 7/32	3 1/2	3 9/16	22.41	10.17
9-6136(W)	4 1/4	6 3/4	6 1/16	6 1/8	2 17/32	3 9/16	3 1/2	3 15/16	26.07	11.83
9-6140(W)	4 3/8	6 3/4	6 1/4	6 1/4	2 9/16	3 9/16	3 1/2	3 7/8	23.69	10.75
9-6144(W)	4 1/2	7	6 1/2	6 1/2	2 9/16	3 13/16	3 1/2	3 7/8	32.92	14.93
9-6148(W)	4 5/8	7	6 1/2	6 13/16	2 11/16	3 13/16	3 1/2	4 9/32	27.25	12.36
9-6152(W)	4 3/4	7	6 9/16	6 5/8	2 3/4	3 13/16	3 17/32	4 9/32	26.07	12.11
9-6156(W)	4 7/8	7 1/2	7	6 5/8	2 3/4	3 15/16	3 3/4	4 3/8	35.29	16.01
9-6160(W)	5	7 1/2	7	7	2 13/16	4 3/16	3 15/16	4 9/16	32.00	14.51
9-6168(W)	5 1/4	7 1/2	7 3/16	7	2 15/16	4 3/16	3 15/16	4 9/16	32.85	14.90
9-6172(W)	5 3/8	7 3/4	7 1/2	7 1/2	3 1/16	4 29/32	3 15/16	4 9/16	36.18	16.41
9-6174(W)	5 7/16	7 3/4	7 1/2	7 1/2	3 1/16	4 29/32	4 1/8	4 15/16	43.00	19.50
9-6180(W)	5 5/8	7 3/4	7 1/4	7 1/2	3 3/8	4 29/32	4 1/8	5 3/16	35.70	16.19
9-6184(W)	5 3/4	8	7 1/4	7 1/2	3 3/8	4 29/32	4 1/8	5 7/16	33.66	15.27
9-6196(W)	6 1/8	8 1/4	8 1/2	8 1/4	3 5/8	5 1/8	4 7/16	5 5/8	46.34	21.02
9-6208(W)	6 1/2	8 1/2	9 1/4	9	3 1/16	5 1/2	4 23/32	5 15/16	66.48	30.15
9-6220(W)	6 7/8	8 3/4	9 1/4	9 7/8	4 9/32	5 3/4	5 1/8	6 3/4	76.50	34.70
9-6232(W)	7 1/4	9	10	10 1/4	4 1/2	5 3/4	5 7/32	7	81.40	36.92
9-6244(W)	7 5/8	9 1/4	10 3/4	10 1/4	4 5/8	5 3/4	5 7/32	7	83.85	38.03
9-6256(W)	8	9 1/4	11	10 1/2	4 5/8	6 3/4	5 13/16	7 1/4	85.38	38.73

(W) WILLIAMS® 为 Snap-on® 旗下品牌之一，专业生产大尺寸工具。



套筒

12角
• 旋转角30°, 易于在狭窄区域工作
6角
• 适用于高扭矩工作

斜切开口
• 紧固件啮合更容易更迅速

中心对称薄壁结构
• 工具更薄更易在狭窄区域工作, 强度也更强

传统12角套筒是与螺母角接触, 高负荷下, 角会磨圆

实耐宝套筒采用Flank Drive® 技术, 套筒接触螺母时圆弧可避开角, 面与面接触, 动力更增加20%

止动棘爪系统
• 四个内壁凹槽可保证任何位置啮合

特殊合金钢
• 强度与耐久性兼备

镀铬表面
• 光滑、坚硬、防腐蚀

识别印记
• 凸边公制套筒, 凹边英制套筒

焊缝对接
• 强度高, 防扭曲

向下折转凸边杆
• 手指易于操控



斜切方头
• 易于方头啮合

镀铬表面
• 光滑、坚硬、防腐蚀

冷轧工艺
• 增加强度、稳定性及耐久性

锁定机构
• 弹簧防止套筒滑落

头部轮廓精巧, 易于在狭窄区域工作

搬动杆坚实耐用

纹路表面镀铬, 使用寿命长

外表面光滑

36齿, 内部机构高强度耐用

整体铸造, 坚实耐用

人体工学手柄, 使用舒适

高强度密封系列



掌中棘轮扳手

密封冷轧棘轮头

1/4", 3/8", 1/2" 方头

接合处, 便于维修

11处可锁位置, 不会打滑, 不会磨损关节

拇指易操控锁定按钮

纹路表面镀铬, 使用寿命长

人体工学手柄, 使用舒适

可锁定活动头系列

